

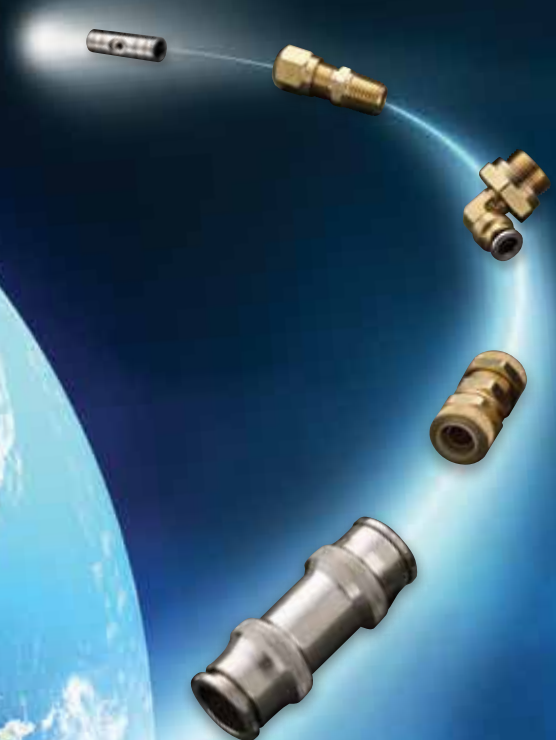

**A WORLD OF
POSSIBILITIES**



FITTINGS PRODUCT CATALOG

Keeping the world moving and working.





Alkon has one of the most extensive lines of pneumatic fittings in the business. We are also one of the largest manufacturers of brass push-to-connect (PTC) fittings in the U.S. and can create custom part orders on short notice.

If you don't know Alkon, maybe you should.



WE'RE IN THE PEOPLE BUSINESS

We use our own fittings and valves in the production machines we build to make your fittings and valves. We know how much quality matters, but the one thing that matters more is making sure you get what you need. Whether it's a custom solution or off the shelf, we want it to be right. That approach builds strong customer relationships.



A PASSION FOR SOLUTIONS

Alkon has developed several innovative, now-patented designs since we opened for business, and we continue to expand our fittings lines with newly tested designs, materials, and more custom solutions than any other supplier. Unlike most of our competitors, we find solutions when others still see problems. We've developed unique technologies for manufacturing our products. We make sure all incoming materials meet our high quality standards.



BORN IN THE U.S.A.

Alkon began as a small startup with a single line in Hawthorne, New Jersey in the mid-1950s and we've continued to grow every year since. Our executives are not only active in the company every day, but passionate about our success.



QUALITY PLEDGE

Alkon Corporation is committed to robust quality and service through continuous improvement, innovative design, dependable delivery and an emphasis on customer relations.

65+ YEARS OF "WE'VE GOT THIS"

Today, we're a leading U.S. manufacturer of brass push-to-connect (PTC) fittings. We have more than 65 years of expertise and the technology to produce custom fittings and valves from the design stage through engineering to manufacturing and delivery.

Of course, we design custom fittings. Give us a short amount of time and we can design, engineer and manufacture exactly the fitting you need.

Need fittings? We've got this.

Corporate Headquarters /
USA Head Office

728 Graham Drive
Fremont, OH 43420
P: 419.333.7000
F: 419.355.9211

Mexico Head Office

Alkon Products, S.A. de C.V.
Destajistas No. 20
Parque Industrial Xhala
Cuautitlan Izcalli EDO. DE MEX.
C.P. 54730, P: 872-46-97
P: 872-58-09, F: 872-31-62

www.alkoncorp.com
sales@alkoncorp.com



Alkon fittings measure up to just about any pneumatics job on Earth. Our products are used on aircraft carriers, refrigerators, heavy equipment, public transit vehicles, and much more, from low riders to high-flying amusement rides.

TABLE OF CONTENTS

HOW TO USE THE ALKON PUSH-IN FITTINGS	5
SERIES AQ NICKEL-PLATED BRASS PUSH-IN FITTINGS.....	6
SERIES PAQ AIR BRAKE COMPOSITE PUSH-IN DOT FITTINGS.....	17
SERIES AQ-DOT AIR BRAKE BRASS PUSH-IN FITTINGS.....	20
SERIES MAQ METRIC BRASS PUSH-IN INDUSTRIAL FITTINGS.....	29
SERIES MAQ-DOT METRIC AIR BRAKE BRASS PUSH-IN FITTINGS	34
BRASS PUSH-IN FITTINGS ORDERING GUIDE.....	37
SERIES AP BRASS TUBE FITTINGS FOR PLASTIC TUBING.....	38
SERIES XQ-DOT AIR BRAKE BRASS PUSH-IN FITTINGS.....	45
CUSTOMIZED FITTINGS	50
SERIES 100 PIPE FITTINGS.....	51
SERIES 29 BARB ADAPTERS.....	57
TUBING ACCESSORIES.....	58
EMERGENCY REPAIR KITS.....	59
MANIFOLDS WITH PRE-INSTALLED PUSH-IN FITTING CARTRIDGES.....	60



IN PNEUMATIC CONNECTIONS, WE DO IT ALL

We can make any product from scratch to your specs, in aluminum, brass, stainless steel or engineered plastics. We manufacture and assemble in short runs and large production, even on short notice.



Fittings: Shaped or straight, swivel or stationary industrial fittings (push-to-connect [PTC], brass pipe, compression-type), manifolds and specialty (MQ manifolds, MTQ connectors and design-your-own).

Alkon fittings are available in nickel-plated brass for lasting durability in harsh operating conditions and in high-demand lightweight composite material. Brass fittings without nickel plating are available anytime.

Valves: Directional control, lockout, 3-way and 4-way, no-lube, lap-spool, sprite, stand-alone, manifolds and stacks, standard or high-temperature sealant, just call us.

Flow Controls: Angle and in-line products and needle valves – all known for high-flow, reliable performance.

For information on Alkon products and services, e-mail us today at sales@alkoncorp.com.



BRASS PUSH-IN FITTINGS

How to Use Alkon Push-In Fittings



TO CONNECT TUBE:

Cut plastic as squarely as possible.

Insert tube into fitting until friction is felt as tube slides past the O-ring.

Using a slight twisting motion while inserting the tube is often helpful.

TO DISCONNECT TUBE:

With thumb and forefinger, hold down the top of the insert against the fitting body, and with the other hand, pull out the tubing. No tools are needed.

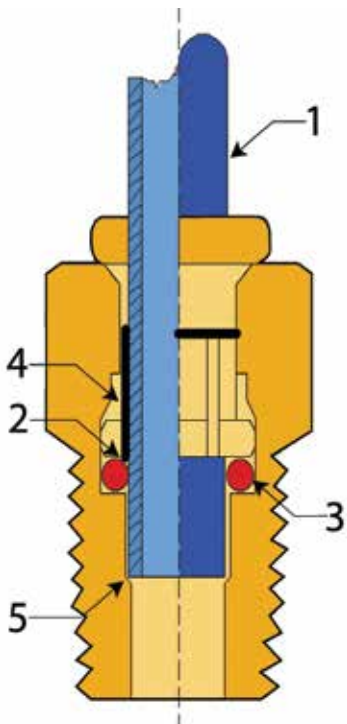

When tubing (1) is inserted into the fitting, it first passes through the gripping teeth (2). Just beyond the gripping teeth is the O-ring (3), which provides the leakproof seal against the O.D. of the tube. The gripping teeth grab the tube, which expands the insert. Pulling back on the tube only tightens the grip as the insert moves onto the camming surface (4).

Pressure through the tube also serves to tighten the grip. The tube bottoms against a positive tube stop (5) in a cavity, providing tube support to prevent leakage.

Alkon Series AQ push-in fittings are designed for compressed air application; for all other applications consult factory.



SERIES AQ

NICKEL-PLATED BRASS
PUSH-IN FITTINGS

The Series AQ push-in fittings family is Alkon's flagship product line. These fittings are available in thousands of standard and custom configurations, all with the same premium quality and performance.

ALKON SERIES AQ FITTINGS ARE:

- ◆ Made here, from raw brass bars to final assembly for total quality control
- ◆ Available in nickel-plated CA 360 and CA 377 brass for high gloss and corrosion resistance
- ◆ Engineered and tested to ensure maximum flow, easy installation and the most reliable airtight seal



ALKON FEATURE	YOUR BENEFIT
Positive seal; more tube support area beyond the O-ring than competing products	Compensates for bias-cut tubing, cuts troubleshooting time dramatically
Swivel elbows and tees	Easier close center-line installation, no orientation problems
Fixed elbows and tees	Utmost in economy
Sealant (LOCTITE® 516 standard; others available) pre-applied to all AQ Series male threads	No charge
Custom part orders are welcome	Get and pay for exactly what you need – nothing more, nothing less

LOCTITE® is a trademark of Henkel Corporation, U.S.A.

SERIES AQ

SPECIFICATIONS

Materials of Construction

Body (straights), tube supports, and grippers: Brass CA 360; forged elbows and tees:

Brass CA377; O-ring; NBR-269, alternate compounds on request.

Temperature Range

-40°F to 220°F
(other ranges available upon request)

Threads

NPTF standard; for other thread standards, consult factory.

Tube O.D. Sizes

Series AQ - 1/8", 5/32", 3/16", 1/4", 3/8", 1/2"

Recommended Tubing

Nylon & Polyethylene

Working Pressure

The fitting is suitable for use up to the maximum working pressure of the recommended tubing.

CAD data available upon request.

NICKEL-PLATED BRASS PUSH-IN FITTINGS

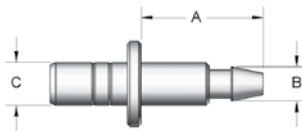

AQ34/32 BARB ADAPTER

Part Number	A	B	C
AQ34-B-1*	0.50	0.09	0.250
AQ34-B-2*	0.50	0.20	0.250

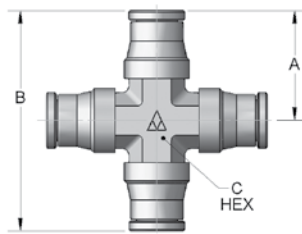

AQ52-N UNION CROSS

Part Number	Tube O.D.	A	B	C
AQ52-N-2	1/8	0.73	1.46	5/16
AQ52-N-5/32*	5/32	0.76	1.52	5/16
AQ52-N-4	1/4	1.05	2.10	3/8
AQ52-N-6	3/8	1.08	2.16	1/2
AQ52-N-8*	1/2	1.26	2.52	5/8

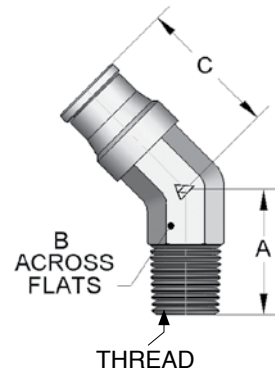

AQ54-N 45° MALE ELBOW

Part Number	Tube O.D.	Pipe	A	B	C
AQ54-N-4X2*	1/4	1/8	0.75	3/8	.99
AQ54-N-4X4*	1/4	1/4	.89	3/8	.99
AQ54-N-6X2*	3/8	1/8	0.75	1/2	.99
AQ54-N-6X4*	3/8	1/4	0.95	1/2	1.08
AQ54-N-6X6*	3/8	3/8	.97	1/2	1.08
AQ54-N-8X4*	1/2	1/4	1.00	5/8	1.20
AQ54-N-8X6*	1/2	3/8	1.05	5/8	1.20
AQ54-N-8X8	1/2	1/2	1.20	5/8	1.20

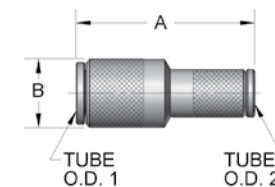

AQ56-N TUBE-TO-TUBE UNION REDUCER

Part Number	Tube O.D. 1	Tube O.D. 2	A	B
AQ56-N-4X5/32*	1/4	5/32	1.43	7/16
AQ56-N-6X4	3/8	1/4	1.85	5/8

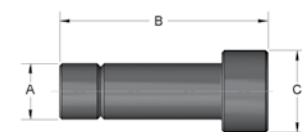

AQ59-N PLUG

Part Number	A	B	C
AQ59-N-2	1/8	1.12	0.35
AQ59-N-5/32	5/32	1.16	0.32
AQ59-N-4	1/4	1.40	0.43
AQ59-N-6	3/8	1.40	0.55
AQ59-N-8	1/2	1.50	0.70

* Made to Order – consult factory for price and availability.

SERIES AQ

NICKEL-PLATED BRASS PUSH-IN FITTINGS

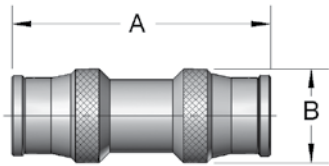

AQ62-N UNION CONNECTOR

Part Number	Tube O.D.	A	B
AQ62-N-2	1/8	1.23	3/8
AQ62-N-5/32	5/32	1.34	3/8
AQ62-N-4	1/4	1.82	7/16
AQ62-N-5	5/16	1.89	19/32
AQ62-N-6	3/8	1.82	21/32
AQ62-N-8	1/2	2.02	25/32

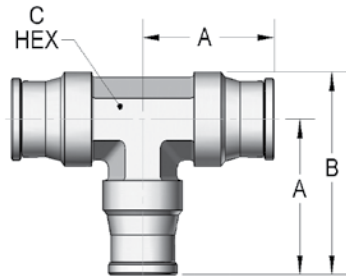

AQ64-N UNION TEE

Part Number	Tube O.D.	A	B	C
AQ64-N-2	1/8	0.73	0.91	5/16
AQ64-N-5/32	5/32	0.76	0.94	5/16
AQ64-N-3	3/16	0.83	1.04	3/8
AQ64-N-4	1/4	0.94	1.17	3/8
AQ64-N-6	3/8	1.08	1.41	1/2
AQ64-N-8	1/2	1.26	1.65	5/8

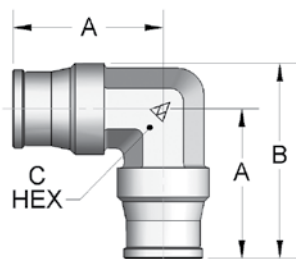

AQ65-N UNION ELBOW

Part Number	Tube O.D.	A	B	C
AQ65-N-2	1/8	0.73	0.91	5/16
AQ65-N-5/32	5/32	0.76	0.94	5/16
AQ65-N-4	1/4	0.94	1.17	3/8
AQ65-N-5	5/16	1.04	1.37	7/16
AQ65-N-6	3/8	1.08	1.41	1/2
AQ65-N-8	1/2	1.26	1.65	5/8

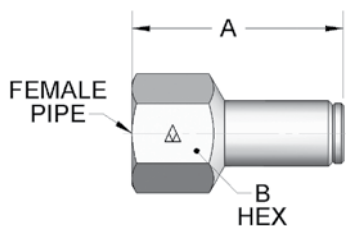

AQ66-N FEMALE CONNECTOR

Part Number	Tube O.D.	Female Pipe	A	B
AQ66-N-2X2	1/8	1/8	1.04	9/16
AQ66-N-5/32X2	5/32	1/8	1.09	9/16
AQ66-N-3X2	3/16	1/8	1.21	9/16
AQ66-N-4X2	1/4	1/8	1.33	9/16
AQ66-N-4X4	1/4	1/4	1.55	3/4
AQ66-N-6X4	3/8	1/4	1.52	3/4
AQ66-N-6X6	3/8	3/8	1.56	7/8
AQ66-N-8X8	1/2	1/2	1.85	1-1/8

SERIES AQ

NICKEL-PLATED BRASS PUSH-IN FITTINGS

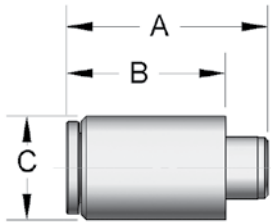

AQ688-N PRESS-IN CARTRIDGE

Part Number	Tube O.D.	A	B	C
AQ688-N-2X00	1/8	0.67	0.47	3/8
AQ688-N-5/32X00	5/32	0.67	0.47	3/8
AQ688-N-3X00*	3/16	0.72	0.57	7/16
AQ688-N-4X00	1/4	0.95	0.69	1/2
AQ688-N-6X00	3/8	1.23	0.97	5/8

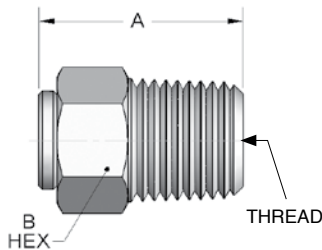

AQ68-N MALE CONNECTOR

Part Number	Tube O.D.	Pipe	A	B
AQ68-N-2X0	1/8	10/32**	0.79	3/8
AQ68-N-2X1	1/8	1/16	0.76	3/8
AQ68-N-2X2	1/8	1/8	0.77	7/16
AQ68-N-2X4	1/8	1/4	0.98	9/16
AQ68-N-5/32X0	5/32	10/32**	0.79	3/8
AQ68-N-5/32X2	5/32	1/8	0.77	7/16
AQ68-N-5/32X4	5/32	1/4	0.95	9/16
AQ68-N-3X0	3/16	10/32**	0.89	3/8
AQ68-N-3X1	3/16	1/16	1.02	3/8
AQ68-N-3X2	3/16	1/8	1.01	7/16
AQ68-N-3X4	3/16	1/4	1.02	9/16
AQ68-N-4X0	1/4	10/32**	0.99	7/16
AQ68-N-4X1	1/4	1/16	1.17	7/16
AQ68-N-4X2	1/4	1/8	0.98	7/16
AQ68-N-4X4	1/4	1/4	0.90	9/16
AQ68-N-4X6	1/4	3/8	0.87	11/16
AQ68-N-5X2	5/16	1/8	1.16	9/16
AQ68-N-5X4	5/16	1/4	1.16	5/8
AQ68-N-5X6	5/16	3/8	1.16	11/16
AQ68-N-6X2	3/8	1/8	1.17	11/16
AQ68-N-6X4	3/8	1/4	1.15	11/16
AQ68-N-6X6	3/8	3/8	1.12	11/16
AQ68-N-6X8	3/8	1/2	1.03	7/8
AQ68-N-8X4	1/2	1/4	1.46	13/16
AQ68-N-8X6	1/2	3/8	1.28	13/16
AQ68-N-8X8	1/2	1/2	1.23	7/8

* Made to Order – consult factory for price and availability.

** Furnished with nylon gasket.

SERIES AQ

NICKEL-PLATED BRASS PUSH-IN FITTINGS

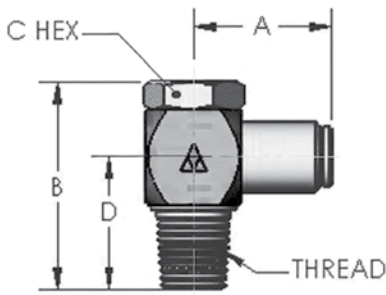

AQ699-NS SWIVEL MALE BANJO ELBOW

Part Number	Tube O.D.	Pipe	A	B	C	D
AQ699-NS-5/32X0	5/32	10/32**	0.71	0.67	5/16	0.46
AQ699-NS-5/32X2*	5/32	1/8	0.76	1.14	1/2	0.69
AQ699-NS-4X2*	1/4	1/8	0.95	1.14	1/2	0.69
AQ699-NS-4X4*	1/4	1/4	0.95	1.49	5/8	0.95
AQ699-NS-4X6*	1/4	3/8	1.08	1.67	3/4	1.09
AQ699-NS-6X4*	3/8	1/4	0.95	1.46	5/8	1.12
AQ699-NS-6X6*	3/8	3/8	1.08	1.67	3/4	1.31

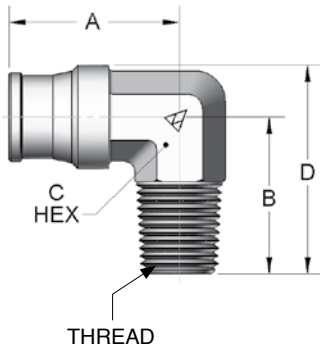

AQ69-N MALE ELBOW

Part Number	Tube O.D.	Pipe	A	B	C	D
AQ69-N-2X2	1/8	1/8	0.77	0.69	5/16	0.87
AQ69-N-5/32X2	5/32	1/8	0.76	0.68	5/16	0.89
AQ69-N-3X2	3/16	1/8	0.83	0.71	3/8	0.92
AQ69-N-4X2	1/4	1/8	0.97	0.79	3/8	0.99
AQ69-N-4X4	1/4	1/4	1.03	0.84	3/8	1.02
AQ69-N-4X6	1/4	3/8	1.08	0.98	1/2	1.27
AQ69-N-6X2	3/8	1/8	1.03	0.80	1/2	1.12
AQ69-N-6X4	3/8	1/4	1.06	0.98	1/2	1.29
AQ69-N-6X6	3/8	3/8	1.05	0.98	1/2	1.31
AQ69-N-8X4	1/2	1/4	1.23	1.05	5/8	1.44
AQ69-N-8X6	1/2	3/8	1.23	1.05	5/8	1.44
AQ69-N-8X8	1/2	1/2	1.24	1.26	5/8	1.64

* Made to Order – consult factory for price and availability.

** Furnished with nylon gasket.

SERIES AQ

NICKEL-PLATED BRASS PUSH-IN FITTINGS

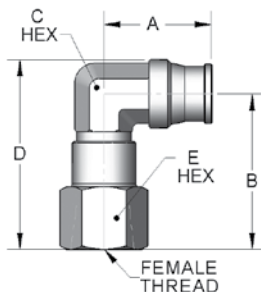
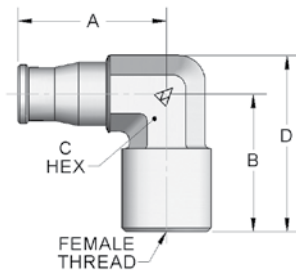
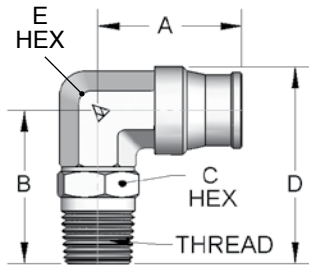

AQ69-NS SWIVEL MALE ELBOW

Part Number	Tube O.D.	Pipe	A	B	C	D	E
AQ69-NS-2X0	1/8	10/32**	0.77	0.79	5/16	0.91	5/16
AQ69-NS-2X2	1/8	1/8	0.76	0.90	7/16	1.11	3/8
AQ69-NS-2X4	1/8	1/4	0.77	1.08	9/16	1.29	3/8
AQ69-NS-5/32X0	5/32	10/32**	0.77	0.79	5/16	0.91	5/16
AQ69-NS-5/32X2	5/32	1/8	0.77	0.88	7/16	1.10	3/8
AQ69-NS-5/32X4	5/32	1/4	0.77	1.08	9/16	1.29	3/8
AQ69-NS-3X2	3/16	1/8	0.84	0.89	7/16	1.11	3/8
AQ69-NS-3X4	3/16	1/4	0.88	1.01	9/16	1.23	3/8
AQ69-NS-4X0	1/4	10/32**	0.96	0.76	5/16	1.00	3/8
AQ69-NS-4X2	1/4	1/8	0.94	0.90	7/16	1.14	3/8
AQ69-NS-4X4	1/4	1/4	1.02	1.09	9/16	1.33	3/8
AQ69-NS-4X6	1/4	3/8	1.02	1.13	11/16	1.37	3/8
AQ69-NS-5X2	5/16	1/8	0.95	1.13	7/16	1.43	7/16
AQ69-NS-5X4	5/16	1/4	0.95	1.26	9/16	1.56	7/16
AQ69-NS-6X2	3/8	1/8	1.05	1.06	7/16	1.39	1/2
AQ69-NS-6X4	3/8	1/4	1.08	1.14	9/16	1.46	1/2
AQ69-NS-6X6	3/8	3/8	1.10	1.23	11/16	1.55	1/2
AQ69-NS-6X8	3/8	1/2	1.10	1.53	7/8	1.85	1/2
AQ69-NS-8X4	1/2	1/4	1.26	1.26	9/16	1.65	5/8
AQ69-NS-8X6	1/2	3/8	1.26	1.31	11/16	1.70	5/8
AQ69-NS-8X8	1/2	1/2	1.25	1.61	7/8	2.00	5/8

AQ70-N FEMALE ELBOW

Part Number	Tube O.D.	Female Pipe	A	B	C	D
AQ70-N-2X2	1/8	1/8	0.78	0.82	3/8	1.04
AQ70-N-5/32X2	5/32	1/8	0.76	0.82	3/8	1.04
AQ70-N-4X2	1/4	1/8	1.02	0.83	3/8	1.06
AQ70-N-4X4	1/4	1/4	1.13	1.03	1/2	1.31
AQ70-N-6X4	3/8	1/4	1.08	0.98	1/2	1.31

AQ70-NS SWIVEL FEMALE ELBOW

Part Number	Tube O.D.	Female Pipe	A	B	C	D	E
AQ70-NS-5/32X2	5/32	1/8	0.73	1.04	3/8	1.22	9/16
AQ70-NS-4X2	1/4	1/8	1.02	1.06	3/8	1.30	9/16
AQ70-NS-4X4	1/4	1/4	0.97	1.25	3/8	1.49	3/4
AQ70-NS-6X4	3/8	1/4	1.08	1.48	1/2**	1.80	3/4
AQ70-NS-6X6*	3/8	3/8	1.10	1.66	1/2	1.99	7/8
AQ70-NS-8X6*	1/2	3/8	1.25	1.70	5/8	2.09	7/8

Made to Order - consult factory for price and availability.
Furnished with nylon basket.

SERIES AQ

NICKEL-PLATED BRASS PUSH-IN FITTINGS

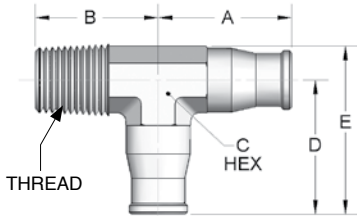

AQ71-N MALE RUN TEE

Part Number	Tube O.D.	Pipe	A	B	C	D	E
AQ71-N-2X2*	1/8	1/8	0.73	0.66	5/16	0.66	0.91
AQ71-N-5/32X2	5/32	1/8	0.75	0.67	5/16	0.75	0.95
AQ71-N-3X2*	3/16	1/8	0.83	0.73	3/8	0.83	1.05
AQ71-N-4X2	1/4	1/8	1.02	0.75	3/8	1.02	1.24
AQ71-N-4X4	1/4	1/4	1.02	0.92	7/16	1.02	1.27
AQ71-N-6X2*	3/8	1/8	1.02	0.92	1/2	1.02	1.29
AQ71-N-6X4	3/8	1/4	1.08	0.98	1/2	1.08	1.40
AQ71-N-6X6	3/8	3/8	1.08	0.98	1/2	1.08	1.31
AQ71-N-8X6*	1/2	3/8	1.26	1.05	5/8	1.26	1.55

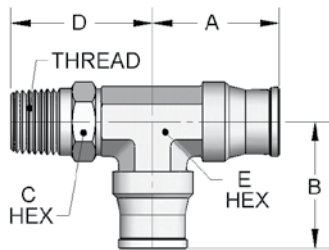

AQ71-NS SWIVEL MALE RUN TEE

Part Number	Tube O.D.	Pipe	A	B	C	D	E
AQ71-NS-2X2	1/8	1/8	0.73	0.73	5/16	0.86	7/16
AQ71-NS-5/32X0*	5/32	10/32**	0.76	0.76	5/16	0.73	5/16
AQ71-NS-5/32X2	5/32	1/8	0.76	0.76	5/16	0.82	7/16
AQ71-NS-4X2	1/4	1/8	1.02	1.02	3/8	1.01	7/16
AQ71-NS-4X4	1/4	1/4	1.02	1.02	7/16	1.08	9/16
AQ71-NS-6X2*	3/8	1/8	1.08	1.08	1/2	1.08	7/16
AQ71-NS-6X4	3/8	1/4	1.04	1.04	1/2	1.15	9/16
AQ71-NS-6X6	3/8	3/8	1.06	1.06	1/2	1.17	11/16
AQ71-NS-8X6*	1/2	3/8	1.24	1.24	5/8	1.28	11/16
AQ71-NS-8X8	1/2	1/2	1.24	1.24	5/8	1.58	7/8

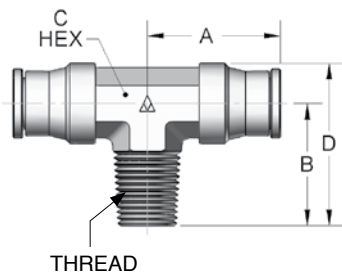

AQ72-N MALE BRANCH TEE

Part Number	Tube O.D.	Pipe	A	B	C	D
AQ72-N-2X2*	1/8	1/8	0.73	0.66	5/16	0.84
AQ72-N-5/32X2	5/32	1/8	0.76	0.66	5/16	0.84
AQ72-N-3X2*	3/16	1/8	0.88	0.78	3/8	1.00
AQ72-N-4X2	1/4	1/8	1.02	0.75	3/8	0.98
AQ72-N-4X4	1/4	1/4	1.02	0.92	7/16	1.16
AQ72-N-6X2	3/8	1/8	1.08	0.80	1/2	1.13
AQ72-N-6X4	3/8	1/4	1.08	0.99	1/2	1.31
AQ72-N-6X6	3/8	3/8	1.09	0.98	1/2	1.31
AQ72-N-8X4*	1/2	1/4	1.26	1.07	5/8	1.45
AQ72-N-8X6*	1/2	3/8	1.26	1.07	5/8	1.45

* Made to Order – consult factory for price and availability.

** Furnished with nylon gasket.

SERIES AQ

NICKEL-PLATED BRASS PUSH-IN FITTINGS

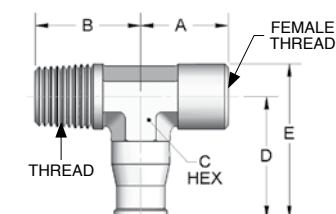
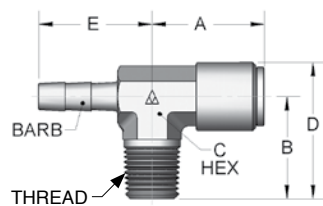
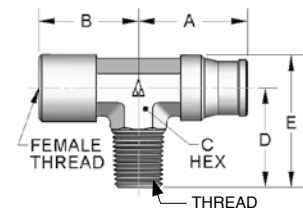
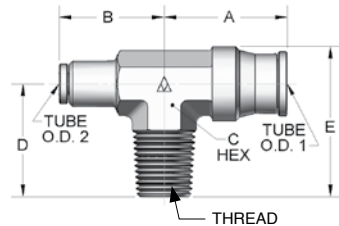
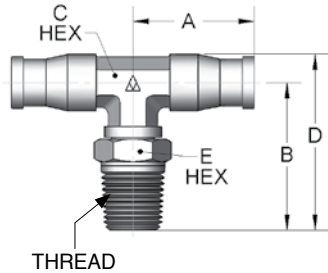

AQ72-NS SWIVEL MALE BRANCH TEE

Part Number	Tube O.D.	Pipe	A	B	C	D	E
AQ72-NS-2X2	1/8	1/8	0.73	0.65	5/16	0.81	7/16
AQ72-NS-5/32X0*	5/32	10/32**	0.76	0.72	5/16	0.90	5/16
AQ72-NS-5/32X2	5/32	1/8	0.78	0.82	3/8	1.00	7/16
AQ72-NS-4X2	1/4	1/8	1.02	1.04	3/8	1.28	7/16
AQ72-NS-4X4	1/4	1/4	1.01	1.23	3/8	1.47	9/16
AQ72-NS-6X2	3/8	1/8	1.08	1.07	1/2	1.40	7/16
AQ72-NS-6X4	3/8	1/4	1.06	1.17	1/2	1.50	9/16
AQ72-NS-6X6	3/8	3/8	1.08	1.21	1/2	1.54	11/16
AQ72-NS-8X6	1/2	3/8	1.26	1.31	5/8	1.70	11/16
AQ72-NS-8X8	1/2	1/2	1.26	1.61	5/8	2.00	7/8

AQ73-N REDUCING MALE BRANCH TEE

Part Number	Tube O.D. 1, O.D. 2	Pipe	A	B	C	D	E
AQ73-N-6X4X2*	3/8, 1/4	1/8	1.08	0.93	1/2	0.98	1.31
AQ73-N-6X4X4*	3/8, 1/4	1/4	1.08	1.02	1/2	0.98	1.31

AQ74-N MALE/FEMALE BRANCH TEE

Part Number	Tube O.D.	M, F Thread	A	B	C	D	E
AQ74-N-4X6X4*	3/8	1/4, 1/4	1.08	0.99	1/2	0.98	1.31

AQ75-N TUBE/BARB MALE BRANCH TEE

Part Number	Tube O.D.	Thread, Barb	A	B	C	D	E
AQ75-N-6X4X4B*	3/8	1/4, 1/4	1.08	0.97	1/2	1.29	1.07

AQ76-N MALE/FEMALE RUN TEE

Part Number	Tube O.D.	Female, Male	A	B	C	D	E
AQ76-N-2X4X2	1/4	1/8, 1/8	0.82	0.82	7/16	1.02	1.29

* Made to Order – consult factory for price and availability.

** Furnished with nylon gasket.

SERIES AQ

NICKEL-PLATED BRASS PUSH-IN FITTINGS

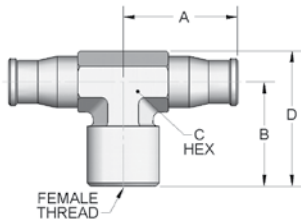

AQ77-N FEMALE BRANCH TEE

Part Number	Tube O.D.	Female Pipe	A	B	C	D
AQ77-N-4X2	1/4	1/8	1.02	0.82	1/2	1.11
AQ77-N-4X4*	1/4	1/4	1.08	0.97	1/2	1.26
AQ77-N-6X4	3/8	1/4	1.09	0.98	1/2	1.31

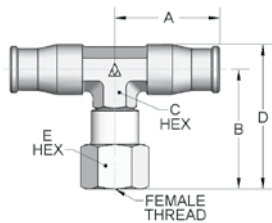

AQ77-NS SWIVEL FEMALE BRANCH TEE

Part Number	Tube O.D.	Female Pipe	A	B	C	D	E
AQ77-NS-4X2*	1/4	1/8	1.02	1.13	3/8	1.36	9/16

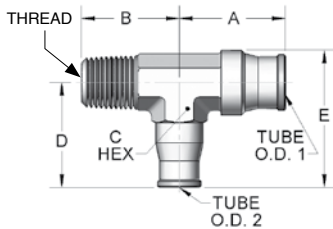

AQ78-N REDUCING MALE RUN TEE

Part Number	Tube O.D. 1	Tube O.D. 2	Pipe	A	B	C	D	E
AQ78-N-6X4X4*	3/8	1/4	1/4	1.08	0.98	1/2	1.08	1.40

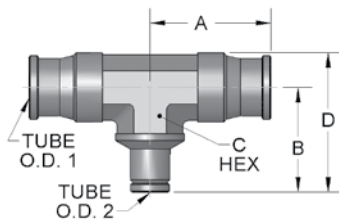

AQ79-N UNION REDUCING TEE

Part Number	Tube O.D. 1	Tube O.D. 2	A	B	C	D
AQ79-N-2X3*	1/8	3/16	0.76	0.78	5/16	0.96
AQ79-N-4X2*	1/4	1/8	0.98	0.90	3/8	1.16
AQ79-N-6X2*	3/8	1/8	1.08	0.92	1/2	1.22
AQ79-N-6X5/32*	3/8	5/32	1.06	0.98	1/2	1.11
AQ79-N-6X4*	3/8	1/4	1.08	1.04	1/2	1.37

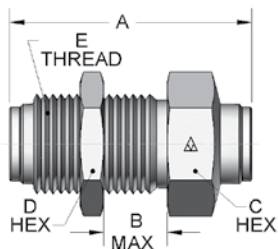

AQ82-N BULKHEAD UNION

Part Number	Tube O.D.	A	B	C	D	E
AQ82-N-2*	1/8	1.28	1.12	5/8	5/8	7/16-20
AQ82-N-5/32	5/32	1.28	1.12	5/8	5/8	7/16-20
AQ82-N-3*	3/16	1.43	1.27	11/16	11/16	1/2-20
AQ82-N-4	1/4	1.90	1.69	11/16	11/16	1/2-20
AQ82-N-6	3/8	1.85	1.69	15/16	15/16	3/14-16
AQ82-N-8	1/2	2.05	1.85	1-1/8	1-1/8	15/16-16

* Made to Order – consult factory for price and availability.

SERIES AQ

NICKEL-PLATED BRASS PUSH-IN FITTINGS

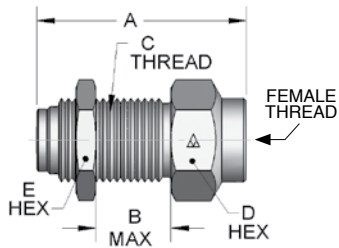

AQ86-N FEMALE BULKHEAD UNION

Part Number	Tube O.D.	Female Pipe	A	B	C	D
AQ86-N-4X2	1/4	1/8	1.29	11/16	1/2-20	0.63
AQ86-N-4X4	1/4	1/4	1.46	3/4	1/2-20	0.63
AQ86-N-6X4	3/8	1/4	1.81	3/4	5/8-18	0.99

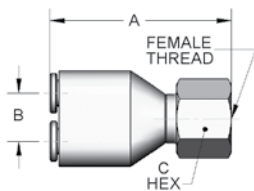

AQ87-N "Y" CONNECTOR FEMALE

Part Number	Tube O.D.	Female Pipe	A	B	C
AQ87-N-4X4*	1/4	1/4	1.98	1.98	3/4

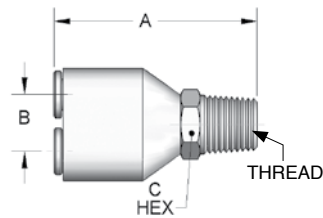

AQ88-N "Y" CONNECTOR MALE NPT TO DUAL AQ TUBE CONNECTOR

Part Number	Tube O.D. 1	Tube O.D. 2	Pipe	A	B	C
AQ88-N-5/32X2*	5/32	5/32	1/8	1.46	0.44	7/16
AQ88-N-5/32X4*	5/32	5/32	1/4	1.64	0.44	9/16
AQ88-N-4X2*	1/4	1/4	1/8	1.83	0.50	7/16
AQ88-N-4X4	1/4	1/4	1/4	2.01	0.50	9/16

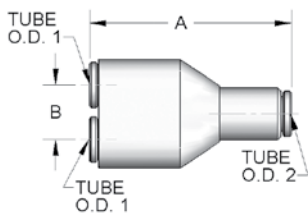

AQ89-N "Y" CONNECTOR TRIPLE TUBE-TO-TUBE-TO-TUBE CONNECTOR

Part Number	Tube O.D. 1	Tube O.D. 2	A	B
AQ89-N-5/32	5/32	5/32	1.39	0.44
AQ89-N-5/32X2*	5/32	1/8	1.37	0.44
AQ89-N-5/32X4*	5/32	1/4	1.63	0.44
AQ89-N-4	1/4	1/4	1.36	0.50
AQ89-N-4X2	1/4	1/8	1.75	0.50
AQ89-N-4X6	1/4	3/8	2.13	0.50
AQ89-N-4X5/32	1/4	5/32	1.78	0.50

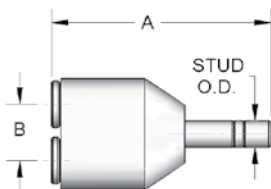

AQ90-N "Y" CONNECTOR DUAL TUBE WITH PLUG-IN MALE STUD

Plug-in stud connects to AQ fitting of same tube O.D. and has through-passage for air.

Part Number	Tube O.D. 1	Tube O.D. 2	Stud O.D.	A	B
AQ90-N-5/32*	5/32	5/32	5/32	1.48	0.44
AQ90-N-5/32X4*	5/32	5/32	1/4	1.70	0.44
AQ90-N-4*	1/4	1/4	1/4	2.07	0.50
AQ90-N-4X5/32*	1/4	1/4	5/32	1.85	0.50

* Made to Order – consult factory for price and availability.

SERIES AQ

NICKEL-PLATED BRASS PUSH-IN FITTINGS

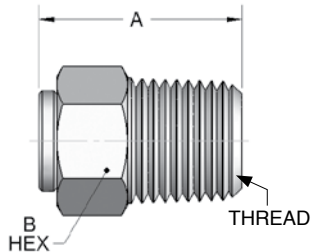

AQ92-N QUICK DISCONNECT

When tube is disconnected, flow shuts off automatically

Part Number	Tube O.D.	Male Pipe	A	B
AQ92-N-4X2	1/4	1/8	0.81	9/16
AQ92-N-4X4	1/4	1/4	1.03	9/16
AQ92-N-6X4*	3/8	1/4	1.16	2.05

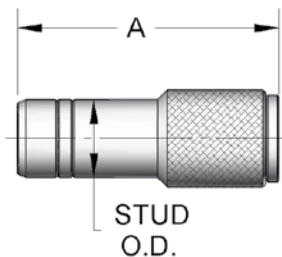

AQ97-N REDUCING UNION

For use with SERIES "AQ" Fittings only

Part Number	Tube O.D.	Stud O.D.	A
AQ97-N-2X4	1/8	1/4	1.38
AQ97-N-5/32X4	5/32	1/4	1.44
AQ97-N-5/32X6*	5/32	3/8	1.44
AQ97-N-4X6	1/4	3/8	1.62
AQ97-N-4X8	1/4	1/2	1.69
AQ97-N-6X8*	3/8	1/2	1.69

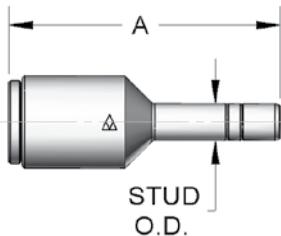

AQ99-N EXPANDER UNION

For use with SERIES "AQ" Fittings only

Part Number	Tube O.D.	Stud O.D.	A
AQ99-N-4X5/32*	1/4	5/32	1.39
AQ99-N-6X4	3/8	1/4	1.66

Viton® O-Ring Seals in Series AQ Fittings

Viton® seals are available from stock in a selected assortment of parts and can be installed in any Series AQ fitting.

To order, just replace "N" or "NS" in any Series AQ part number with "V" or "VS".

Consult Alkon for availability of AFLAS, EPR, EPDM and other O-ring seals in Series AQ fittings.

Viton® is a registered trademark of DuPont Dow Elastomers.



* Made to Order – consult factory for price and availability.



SERIES PAQ

AIR BRAKE COMPOSITE PUSH-IN
DOT FITTINGS

Series PAQ fittings are the ideal solution at half the weight or less. Revolutionary in their design with a high-strength and lightweight composite material tough enough to meet DOT requirements.

Configurations/functions: Inches, shaped or straight, swivel push-in fittings.

DOT-approved: Series PAQ fittings meet or exceed DOT FMVSS 571.106, SAE J113 and J2494-1 & J2494-3 air brake performance requirements.

ALKON SERIES PAQ FITTINGS ARE:

- ◆ Up to 50% lighter than Alkon brass DOT fittings
- ◆ Designed for easy access, easier repairs
- ◆ Available as specials/custom orders, even on short notice – just ask!



ALKON FEATURE	YOUR BENEFIT
Deeper tube insertion depth	Compensates for bias-cut tubing, cuts troubleshooting time dramatically
Longer floating tube support	Tubing stays round, even with side load, for reliable airflow
Brass tube and thread connection	Durability you can count on
Removable collet and wide, easily accessible wrench flats	Easier seal and collet repair
Swivel elbows and tees	Easier close center-line installation, no orientation problems
Pre-applied ST-3® Thread Sealant on all male threads	No charge
Custom part orders are welcome	Get and pay for exactly what you need – nothing more, nothing less

ST-3® is a trademark of ND Industries.

SERIES PAQ

AIR BRAKE COMPOSITE PUSH-IN DOT FITTINGS

SPECIFICATIONS

Temperature Range: -40°F to 220°F | Others available upon request
 Threads: 1/8" - 1/2"
 Recommended Tubing: J844 Air Brake Tubing

Alkon AQ-DOT Series meet D.O.T. FMVSS 571.106 Air Brake Performance Requirements; SAE J1131, J2494-1 & J2494-3 Air Brake Performance Requirements



PAQ54 SWIVEL 45° MALE ELBOW

Part Number	Tube O.D.	Thread (NPTF)	A	B	C Hex
PAQ54-DOTS-4X2	1/4	1/8	1.03	0.98	5/8
PAQ54-DOTS-4X4	1/4	1/4	1.03	1.12	5/8
PAQ54-DOTS-4X6	1/4	3/8	1.03	1.12	3/4
PAQ54-DOTS-6X4	3/8	1/4	1.09	1.18	3/4
PAQ54-DOTS-6X6	3/8	3/8	1.09	1.18	3/4
PAQ54-DOTS-6X8	3/8	1/2	1.09	1.39	7/8
PAQ54-DOTS-8X6	1/2	3/8	1.13	1.23	7/8
PAQ54-DOTS-8X8	1/2	1/2	1.13	1.44	7/8



PAQ62 UNION CONNECTOR

Part Number	Tube O.D.	A	B
PAQ62-DOT-4	1/4	1.90	0.57
PAQ62-DOT-6	3/8	1.90	0.71
PAQ62-DOT-8	1/2	1.90	0.89



PAQ64 UNION TEE

Part Number	Tube O.D.	A	B
PAQ64-DOT-4	1/4	1.12	1.41
PAQ64-DOT-6	3/8	1.18	1.53
PAQ64-DOT-8	1/2	1.24	1.69



PAQ65 UNION ELBOW

Part Number	Tube O.D.	A	B
PAQ65-DOT-4	1/4	1.12	1.41
PAQ65-DOT-6	3/8	1.18	1.53
PAQ65-DOT-8	1/2	1.24	1.69

SERIES PAQ

AIR BRAKE COMPOSITE PUSH-IN DOT FITTINGS

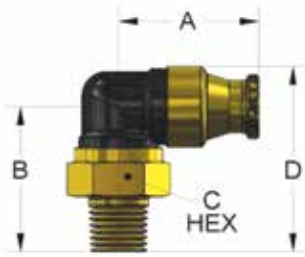

PAQ69 SWIVEL 90° MALE ELBOW

Part Number	Tube O.D.	Thread (NPTF)	A	B	C Hex	D
PAQ69-DOTS-4X2	1/4	1/8	1.12	1.06	5/8	1.35
PAQ69-DOTS-4X4	1/4	1/4	1.12	1.21	5/8	1.50
PAQ69-DOTS-4X6	1/4	3/8	1.12	1.21	3/4	1.50
PAQ69-DOTS-6X2	3/8	1/8	1.18	1.16	3/4	1.51
PAQ69-DOTS-6X4	3/8	1/4	1.18	1.27	3/4	1.63
PAQ69-DOTS-6X6	3/8	3/8	1.18	1.27	3/4	1.63

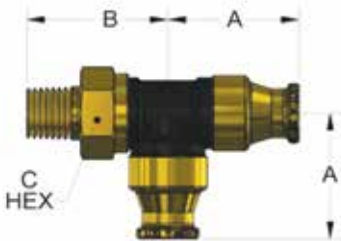

PAQ71 SWIVEL MALE RUN TEE

Part Number	Tube O.D.	Thread (NPTF)	A	B	C Hex	D
PAQ71-DOTS-4X2	1/4	1/8	1.12	1.06	5/8	1.35
PAQ71-DOTS-4X4	1/4	1/4	1.12	1.21	5/8	1.50
PAQ71-DOTS-4X6	1/4	3/8	1.12	1.21	3/4	1.50
PAQ71-DOTS-6X4	3/8	1/4	1.18	1.27	3/4	1.63

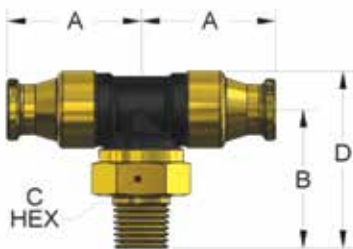

PAQ72 SWIVEL MALE BRANCH TEE

Part Number	Tube O.D.	Thread (NPTF)	A	B	C Hex	D
PAQ72-DOTS-4X2	1/4	1/8	1.12	1.06	5/8	1.35
PAQ72-DOTS-4X4	1/4	1/4	1.12	1.21	5/8	1.50
PAQ72-DOTS-4X6	1/4	3/8	1.12	1.21	3/4	1.50
PAQ72-DOTS-6X4	3/8	1/4	1.18	1.27	3/4	1.63



SERIES AQ-DOT

AIR BRAKE BRASS PUSH-IN FITTINGS

Reliability is always critical, and even more so when you're hauling a heavy load.

Couple that application with the brutal environment of the road and you have a big responsibility riding on a small part.

Alkon Series AQ-DOT fittings are made specifically to meet that challenge.

ALKON SERIES AQ-DOT PUSH-IN FITTINGS ARE:

- ◆ Designed to cut assembly time up to 75%
- ◆ Available in custom sizes, designs and assemblies on short notice



ALKON FEATURE	YOUR BENEFIT
Positive seal; more tube support area beyond the O-ring than competing products	Compensates for bias-cut tubing, cuts troubleshooting time dramatically
Swivel elbows and tees	Easier close center-line installation, no orientation problems
Fixed elbows and tees	Utmost in economy
Sealant (LOCTITE® 516 standard; others available) pre-applied to all AQ-DOT Series male threads	No charge
Custom part orders are welcome	Get and pay for exactly what you need – nothing more, nothing less

LOCTITE® is a trademark of Henkel Corporation, U.S.A.

SERIES AQ-DOT

AIR BRAKE BRASS PUSH-IN FITTINGS

SPECIFICATIONS

Temperature Range: -40°F to 220°F
 Threads: NPTF Standard
 Recommended Tubing: J844 Air Brake

Tubing

Alkon AQ-DOT Series meet D.O.T. FMVSS 571.106 Air Brake Performance Requirements;
 SAE J1131, J2494-1 & J2494-3 Air Brake Performance Requirements

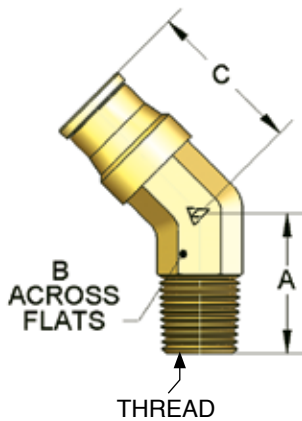

AQ54-DOT 45° MALE ELBOW

Part Number	Tube O.D.	Pipe	A	B	C
AQ54-DOT-4X2	1/4	1/8	0.75	3/8	0.99
AQ54-DOT-4X4	1/4	1/4	0.89	3/8	0.99
AQ54-DOT-6X2	3/8	1/8	0.75	1/2	0.99
AQ54-DOT-6X4	3/8	1/4	0.95	1/2	1.08
AQ54-DOT-6X6	3/8	3/8	0.97	1/2	1.08
AQ54-DOT-6X8	3/8	1/2	1.13	5/8	1.15
AQ54-DOT-8X4	1/2	1/4	1.00	5/8	1.20
AQ54-DOT-8X6	1/2	3/8	1.05	5/8	1.20
AQ54-DOT-8X8	1/2	1/2	1.20	5/8	1.20
AQ54-DOT-10X6*	5/8	3/8	1.17	11/16	1.22
AQ54-DOT-10X8	5/8	1/2	1.31	11/16	1.22
AQ54-DOT-12X8*	3/4	1/2	1.36	15/16	1.18
AQ54-DOT-12X12*	3/4	3/4	1.36	15/16	1.18

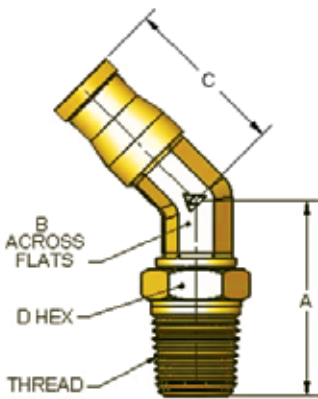

AQ54-DOT SWIVEL 45° MALE ELBOW

Part Number	Tube O.D.	Pipe	A	B	C	D
AQ54-DOTS-4X2	1/4	1/8	0.98	3/8	0.99	7/16
AQ54-DOTS-4X4	1/4	1/4	1.06	3/8	0.99	7/16
AQ54-DOTS-6X2	3/8	1/8	1.08	1/2	1.06	7/16
AQ54-DOTS-6X4	3/8	1/4	1.13	1/2	1.06	9/16
AQ54-DOTS-6X6	3/8	3/8	1.23	1/2	1.08	11/16
AQ54-DOTS-6X8	3/8	1/2	1.46	1/2	1.08	7/8
AQ54-DOTS-8X4*	1/2	1/4	1.22	5/8	1.22	9/16
AQ54-DOTS-8X6	1/2	3/8	1.31	5/8	1.20	11/16
AQ54-DOTS-8X8	1/2	1/2	1.61	5/8	1.20	7/8
AQ54-DOTS-10X6	5/8	3/8	1.38	11/16	1.33	11/16
AQ54-DOTS-10X8	5/8	1/2	1.68	11/16	1.39	7/8

* Made to Order – consult factory for price and availability.

SERIES AQ-DOT

AIR BRAKE BRASS PUSH-IN FITTINGS

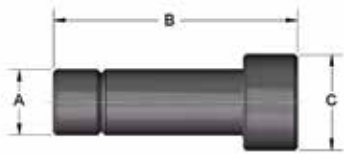

AQ59 NYLON PLUG

Part Number	A
AQ59-P-5/32	5/32
AQ59-P-4	1/4
AQ59-P-6	3/8
AQ59-P-8	1/2

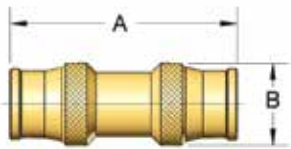

AQ62-DOT UNION CONNECTOR

Part Number	Tube O.D.	A	B
AQ62-DOT-5/32	5/32	1.38	3/8
AQ62-DOT-3	3/16	1.60	7/16
AQ62-DOT-4	1/4	1.82	7/16
AQ62-DOT-5	5/16	1.89	19/32
AQ62-DOT-6	3/8	1.82	21/32
AQ62-DOT-8	1/2	2.02	25/32
AQ62-DOT-10	5/8	2.04	0.91
AQ62-DOT-12	3/4	2.20	1.06

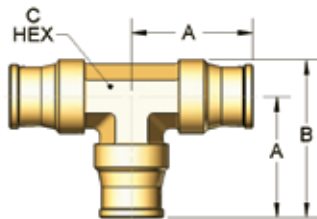

AQ64-DOT UNION TEE

Part Number	Tube O.D.	A	B	C
AQ64-DOT-4	1/4	0.94	1.17	3/8
AQ64-DOT-6	3/8	1.08	1.41	1/2
AQ64-DOT-8	1/2	1.26	1.65	5/8
AQ64-DOT-10	5/8	1.32	1.77	11/16
AQ64-DOT-12*	3/4	1.44	1.99	15/16

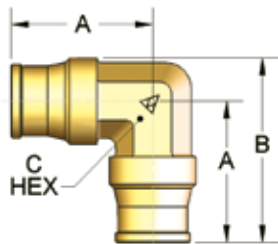

AQ65-DOT UNION ELBOW

Part Number	Tube O.D.	A	B	C
AQ65-DOT-4	1/4	0.94	1.17	3/8
AQ65-DOT-6	3/8	1.08	1.41	1/2
AQ65-DOT-8	1/2	1.26	1.65	5/8

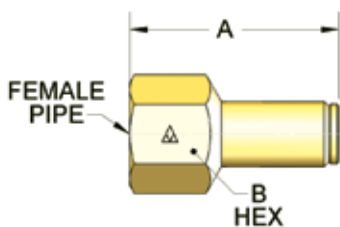

AQ66-DOT FEMALE CONNECTOR

Part Number	Tube O.D.	Female Pipe	A	B
AQ66-DOT-4X2	1/4	1/8	1.33	9/16
AQ66-DOT-4X4	1/4	1/4	1.55	3/4
AQ66-DOT-5/32X2	5/32	1/8	1.09	9/16
AQ66-DOT-6X2	3/8	1/8	1.33	11/16
AQ66-DOT-6X4	3/8	1/4	1.52	3/4
AQ66-DOT-6X6	3/8	3/8	1.56	7/8
AQ66-DOT-8X6*	1/2	3/8	1.59	7/8

* Made to Order – consult factory for price and availability.

SERIES AQ-DOT

AIR BRAKE BRASS PUSH-IN FITTINGS

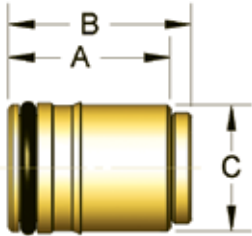

AQ688-DOT PRESS-IN CARTRIDGE

Part Number	Tube O.D.	A	B	C
AQ688-DOT-5/32*	5/32	0.59	0.69	0.32
AQ688-DOT-3*	3/16	0.68	0.78	0.41
AQ688-DOT-4*	1/4	0.76	0.86	0.41
AQ688-DOT-4X6*	1/4	0.81	0.91	0.64
AQ688-DOT-6*	3/8	0.82	0.92	0.64
AQ688-DOT-8*	1/2	0.92	1.02	0.77

AQ68-DOT MALE CONNECTOR

Part Number	Tube O.D.	Pipe	A	B
AQ68-DOT-5/32X1	5/32	1/16	0.78	3/8
AQ68-DOT-5/32X2	5/32	1/8	0.79	7/16
AQ68-DOT-5/32X4	5/32	1/4	0.95	9/16
AQ68-DOT-3X0	3/16	10/32	0.89	3/8
AQ68-DOT-3X1	3/16	1/16	1.02	3/8
AQ68-DOT-3X2	3/16	1/8	1.02	7/16
AQ68-DOT-3X4	3/16	1/4	1.02	9/16
AQ68-DOT-4XM16	1/4	M16	0.91	7/8
AQ68-DOT-4X1	1/4	1/16	1.17	7/16
AQ68-DOT-4X2	1/4	1/8	0.98	7/16
AQ68-DOT-4X4	1/4	1/4	0.90	9/16
AQ68-DOT-4X6*	1/4	3/8	0.87	11/16
AQ68-DOT-6X2	3/8	1/8	1.17	11/16
AQ68-DOT-6X4	3/8	1/4	1.15	11/16
AQ68-DOT-6X6	3/8	3/8	1.12	11/16
AQ68-DOT-6X8	3/8	1/2	1.03	7/8
AQ68-DOT-6XM12	3/8	M12	1.33	11/16
AQ68-DOT-6XM16	3/8	M16	1.25	7/8
AQ68-DOT-8X4	1/2	1/4	1.46	13/16
AQ68-DOT-8X6	1/2	3/8	1.28	13/16
AQ68-DOT-8X8	1/2	1/2	1.23	7/8
AQ68-DOT-8X12	1/2	3/4	1.29	1-1/16
AQ68-DOT-8XM16	1/2	M16	1.41	7/8
AQ68-DOT-8XM22	1/2	M22	1.10	1-1/16
AQ68-DOT-10X6	5/8	3/8	1.44	15/16
AQ68-DOT-10X8	5/8	1/2	1.59	15/16
AQ68-DOT-10X12	5/8	3/4	1.13	1-1/16
AQ68-DOT-10XM22	5/8	M22	1.10	1-1/16
AQ68-DOT-12X8	3/4	1/2	1.65	1-1/16
AQ68-DOT-12X12	3/4	3/4	1.38	1-1/16

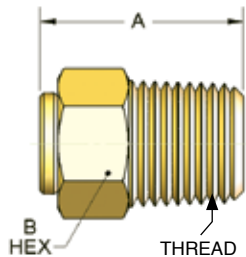

* Made to Order – consult factory for price and availability.

SERIES AQ-DOT

AIR BRAKE BRASS PUSH-IN FITTINGS

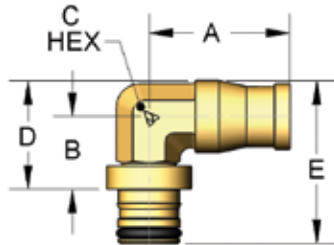

AQ698-DOTS PRESS-IN CARTRIDGE ELBOW

Part Number	Tube O.D.	A	B	C	D	E
AQ698-DOTS-5/32*	5/32	0.79	0.46	3/8	0.64	1.04
AQ698-DOTS-4*	1/4	0.99	0.48	3/8	0.70	1.05
AQ698-DOTS-6*	3/8	1.08	0.63	1/2	0.92	1.35
AQ698-DOTS-8*	1/2	1.26	0.77	5/8	1.13	1.66

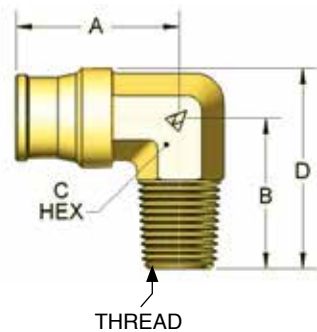

AQ69-DOT MALE ELBOW

Part Number	Tube O.D.	Pipe	A	B	C	D
AQ69-DOT-5/32X1	5/32	1/16	0.78	0.65	5/16	0.82
AQ69-DOT-5/32X2	5/32	1/8	0.78	0.69	5/16	0.89
AQ69-DOT-3X2	3/16	1/8	0.88	0.75	3/8	0.97
AQ69-DOT-4X2	1/4	1/8	1.01	0.79	3/8	0.99
AQ69-DOT-4X4	1/4	1/4	1.05	0.84	3/8	1.07
AQ69-DOT-4X6	1/4	3/8	1.10	0.98	1/2	1.27
AQ69-DOT-6X2	3/8	1/8	1.00	0.80	1/2	1.12
AQ69-DOT-6X4	3/8	1/4	1.10	0.98	1/2	1.29
AQ69-DOT-6X6	3/8	3/8	1.08	0.98	1/2	1.31
AQ69-DOT-6X8	3/8	1/2	1.14	1.20	5/8	1.56
AQ69-DOT-8X4	1/2	1/4	1.26	1.05	5/8	1.44
AQ69-DOT-8X6	1/2	3/8	1.26	1.05	5/8	1.44
AQ69-DOT-8X8	1/2	1/2	1.25	1.26	5/8	1.64
AQ69-DOT-10X6	5/8	3/8	1.25	1.26	5/8	1.59
AQ69-DOT-10X8	5/8	1/2	1.34	1.29	11/16	1.74
AQ69-DOT-12X8	3/4	1/2	1.32	1.36	15/16	1.90
AQ69-DOT-12X12	3/4	3/4	1.32	1.36	15/16	1.90

Quality Assured

Our people go the extra mile to meet your precise specifications in Alkon's complete quality lab. It's part of our Quality Pledge to you.



* Made to Order – consult factory for price and availability.

SERIES AQ-DOT

AIR BRAKE BRASS PUSH-IN FITTINGS

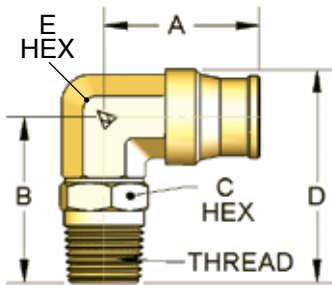

AQ69-DOTS SWIVEL MALE ELBOW

Part Number	Tube O.D.	Pipe	A	B	C	D	E
AQ69-DOTS-5/32X2	5/32	1/8	0.79	0.88	7/16	1.10	3/8
AQ69-DOTS-5/32X4*	5/32	1/4	0.79	1.08	9/16	1.29	3/8
AQ69-DOTS-3X2	3/16	1/8	0.88	0.92	7/16	1.13	3/8
AQ69-DOTS-4X0	1/4	10/32	0.96	0.76	5/16	1.00	3/8
AQ69-DOTS-4X2	1/4	1/8	0.94	0.90	7/16	1.13	3/8
AQ69-DOTS-4X4	1/4	1/4	0.99	1.09	9/16	1.33	3/8
AQ69-DOTS-4X6	1/4	3/8	1.02	1.13	11/16	1.37	3/8
AQ69-DOTS-4XM12	1/4	M12	0.94	1.06	11/16	1.36	3/8
AQ69-DOTS-6X2	3/8	1/8	1.05	1.06	7/16	1.39	1/2
AQ69-DOTS-6X4	3/8	1/4	1.08	1.14	9/16	1.46	1/2
AQ69-DOTS-6X6	3/8	3/8	1.10	1.23	11/16	1.55	1/2
AQ69-DOTS-6X8	3/8	1/2	1.10	1.53	7/8	1.85	1/2
AQ69-DOTS-6X12	3/8	3/4	1.10	1.53	1-1/16	1.86	1/2
AQ69-DOTS-6XM12	3/8	M12	1.10	1.29	11/16	1.62	1/2
AQ69-DOTS-6XM16	3/8	M16	1.10	1.29	7/8	1.62	1/2
AQ69-DOTS-6XM22	3/8	M22	1.10	1.29	1-1/16	1.62	1/2
AQ69-DOTS-8X4	1/2	1/4	1.26	1.26	9/16	1.65	5/8
AQ69-DOTS-8X6	1/2	3/8	1.26	1.31	11/16	1.70	5/8
AQ69-DOTS-8X8	1/2	1/2	1.25	1.61	7/8	2.00	5/8
AQ69-DOTS-8X12	1/2	3/4	1.25	1.55	1-1/16	1.94	5/8
AQ69-DOTS-8XM22	1/2	M22	1.25	1.33	1-1/16	1.72	5/8
AQ69-DOTS-10X6	5/8	3/8	1.54	1.41	11/16	1.86	11/16
AQ69-DOTS-10X8	5/8	1/2	1.54	1.71	7/8	2.16	11/16
AQ69-DOTS-10X12	5/8	3/4	1.54	1.71	1-1/16	2.16	11/16
AQ69-DOTS-10XM22	5/8	M22	1.54	1.49	1-1/16	1.95	11/16
AQ69-DOTS-12X6	3/4	3/8	1.32	1.61	15/16	2.15	15/16
AQ69-DOTS-12X8	3/4	1/2	1.40	2.04	1-1/16	2.46	15/16
AQ69-DOTS-12X12	3/4	3/4	1.40	1.60	1-1/16	2.14	15/16

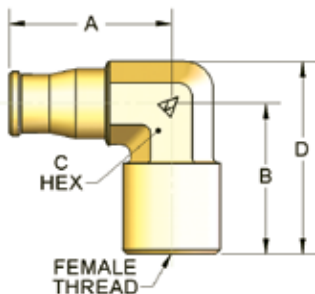

AQ70-DOT FEMALE ELBOW

Part Number	Tube O.D.	Female Pipe	A	B	C	D
AQ70-DOT-4X2	1/4	1/8	1.02	0.83	3/8	1.06
AQ70-DOT-4X4	1/4	1/4	1.13	1.03	1/2	1.31
AQ70-DOT-4X6*	1/4	3/8	1.27	0.99	5/8	1.35
AQ70-DOT-6X4	3/8	1/4	1.08	0.98	1/2	1.31
AQ70-DOT-6X6	3/8	3/8	1.08	1.05	5/8	1.41
AQ70-DOT-8X8*	1/2	1/2	1.37	1.31	5/8	1.70

* Made to Order – consult factory for price and availability.

SERIES AQ-DOT

AIR BRAKE BRASS PUSH-IN FITTINGS

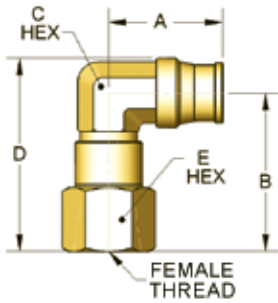

AQ70-DOTS SWIVEL FEMALE ELBOW

Part Number	Tube O.D.	Female Pipe	A	B	C	D	E
AQ70-DOTS-4X2	1/4	1/8	0.94	1.09	3/8	1.33	9/16
AQ70-DOTS-4X4	1/4	1/4	0.97	1.25	3/8	1.49	3/4
AQ70-DOTS-6X4	3/8	1/4	1.10	1.48	1/2	1.80	3/4

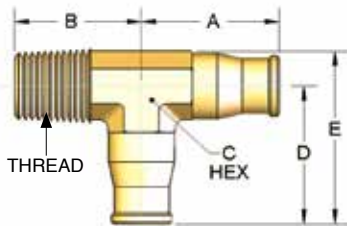

AQ71-DOT MALE RUN TEE

Part Number	Tube O.D.	Pipe	A	B	C	D	E
AQ71-DOT-4X2	1/4	1/8	1.02	0.75	3/8	1.02	1.24
AQ71-DOT-4X4	1/4	1/4	1.02	0.92	7/16	1.02	1.27
AQ71-DOT-4X6	1/4	3/8	1.08	0.98	1/2	1.08	1.42
AQ71-DOT-6X4	3/8	1/4	1.08	0.98	1/2	1.08	1.40
AQ71-DOT-6X6	3/8	3/8	1.08	0.98	1/2	1.08	1.31
AQ71-DOT-8X6*	1/2	3/8	1.26	1.05	5/8	1.26	1.55

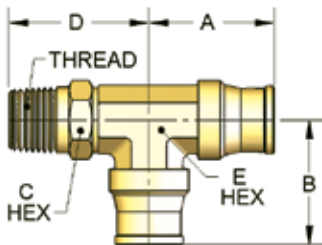

AQ71-DOTS SWIVEL MALE RUN TEE

Part Number	Tube O.D.	Pipe	A	B	C	D	E
AQ71-DOTS-4X2	1/4	1/8	1.02	1.02	3/8	1.01	7/16
AQ71-DOTS-4X4	1/4	1/4	1.02	1.02	7/16	1.08	9/16
AQ71-DOTS-6X4	3/8	1/4	1.04	1.04	1/2	1.15	9/16
AQ71-DOTS-6X6	3/8	3/8	1.06	1.06	1/2	1.17	11/16
AQ71-DOTS-8X6	1/2	3/8	1.24	1.24	5/8	1.28	11/16
AQ71-DOTS-8X8	1/2	1/2	1.24	1.24	5/8	1.58	7/8

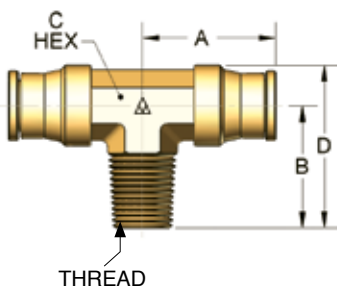

AQ72-DOT MALE BRANCH TEE

Part Number	Tube O.D.	Pipe	A	B	C	D
AQ72-DOT-4X2	1/4	1/8	1.02	0.75	3/8	0.98
AQ72-DOT-4X4	1/4	1/4	1.02	0.92	7/16	1.17
AQ72-DOT-6X2	3/8	1/8	1.08	0.79	1/2	1.11
AQ72-DOT-6X4	3/8	1/4	1.08	0.99	1/2	1.31
AQ72-DOT-6X6	3/8	3/8	1.09	0.99	1/2	0.31
AQ72-DOT-8X4*	1/2	1/4	1.26	1.07	5/8	1.45
AQ72-DOT-8X6	1/2	3/8	1.26	1.07	5/8	1.45

* Made to Order – consult factory for price and availability.

SERIES AQ-DOT

AIR BRAKE BRASS PUSH-IN FITTINGS

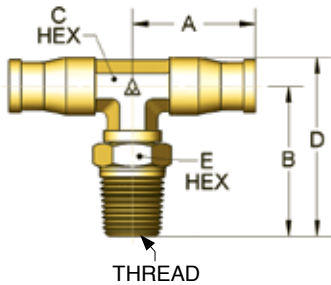

AQ72-DOTS SWIVEL MALE BRANCH TEE

Part Number	Tube O.D.	Pipe	A	B	C	D	E
AQ72-DOTS-3X2	3/16	1/8	0.88	1.04	3/8	1.26	7/16
AQ72-DOTS-4X2	1/4	1/8	1.02	1.04	3/8	1.28	7/16
AQ72-DOTS-4X4	1/4	1/4	1.01	1.04	3/8	1.30	9/16
AQ72-DOTS-6X2	3/8	1/8	1.08	1.07	1/2	1.40	7/16
AQ72-DOTS-6X4	3/8	1/4	1.06	1.17	1/2	1.50	9/16
AQ72-DOTS-6X6	3/8	3/8	1.08	1.21	1/2	1.54	11/16
AQ72-DOTS-6X8	3/8	1/2	1.08	1.40	1/2	1.70	7/8
AQ72-DOTS-6XM12	3/8	M12	1.08	1.30	1/2	1.63	11/16
AQ72-DOTS-6XM16	3/8	M16	1.08	1.30	1/2	1.63	7/8
AQ72-DOTS-6XM22	3/8	M22	1.08	1.30	1/2	1.63	1-1/16
AQ72-DOTS-8X4	1/2	1/4	1.26	1.28	5/8	1.67	9/16
AQ72-DOTS-8X6	1/2	3/8	1.26	1.31	5/8	1.70	11/16
AQ72-DOTS-8X8	1/2	1/2	1.26	1.61	5/8	2.00	7/8
AQ72-DOTS-10X8	5/8	1/2	1.32	1.74		2.20	7/8

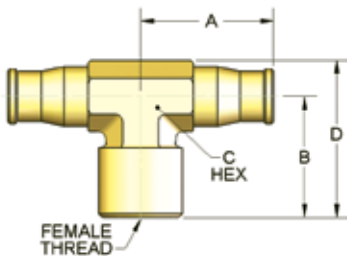

AQ77-DOT FEMALE BRANCH TEE

Part Number	Tube O.D.	Female Pipe	A	B	C	D
AQ77-DOT-4X2	1/4	1/8	1.02	0.82	1/2	1.11
AQ77-DOT-4X4	1/4	1/4	1.08	0.97	1/2	1.26
AQ77-DOT-6X4	3/8	1/4	1.09	0.98	1/2	1.31
AQ77-DOT-6X6*	3/8	3/8	1.40	1.30		1.70
AQ77-DOT-8X4	1/2	1/4	1.26	1.16	5/8	1.55

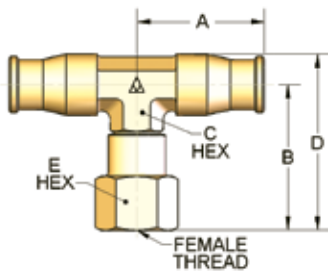

AQ77-DOTS SWIVEL FEMALE BRANCH TEE

Part Number	Tube O.D.	Female Pipe	A	B	C	D	E
AQ77-DOTS-4X2*	1/4	1/8	1.02	1.13	3/8	1.36	9/16
AQ77-DOTS-4X4*	1/4	1/4	1.02	1.29	3/8	1.52	3/4
AQ77-DOTS-6X2	3/8	1/8	1.08	1.18	1/2	1.51	9/16
AQ77-DOTS-6X4*	3/8	1/4	1.08	1.16	1/2	1.49	3/4

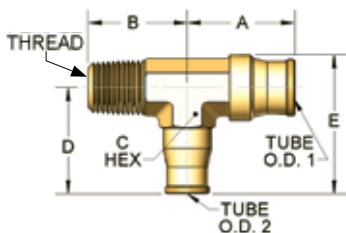

AQ78-DOT REDUCING MALE RUN TEE

* Made to Order – consult factory for price and availability.

SERIES AQ-DOT

AIR BRAKE BRASS PUSH-IN FITTINGS

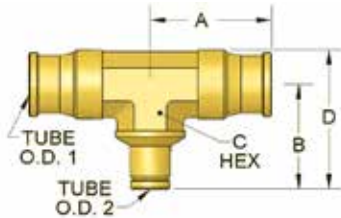

AQ79-DOT UNION REDUCING TEE

Part Number	Tube O.D. 1	Tube O.D. 2	A	B	C	D
AQ79-DOT-4X6	1/4	3/8	1.00	1.08	1/2	1.23
AQ79-DOT-6X5/32	3/8	5/32	1.08	0.85	1/2	1.08
AQ79-DOT-6X2	3/8	1/8	1.08	0.94	1/2	1.27
AQ79-DOT-6X4	3/8	1/4	1.08	1.04	1/2	1.37

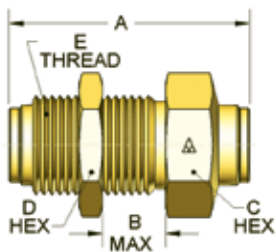

AQ82-DOT BULKHEAD UNION

Part Number	Tube O.D. 1	A	B	C	D	E
AQ82-DOT-4	1/4	1.90	1.00	11/16	11/16	1/2-20
AQ82-DOT-6	3/8	1.85	1.00	15/16	15/16	3/4-16
AQ82-DOT-8	1/2	2.05	1.82	15/16	1-1/8	15/16-16
AQ82-DOT-10	5/8	2.05	0.94	1-1/4	1-3/8	1/14

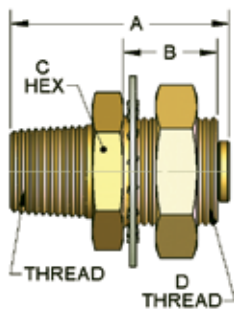

AQ83-DOT GLADHAND MALE BULKHEAD CONNECTOR

Part Number	Tube O.D. 1	Male Pipe	A	B	C	D
AQ83-DOT-6X8*	3/8	1/2	1.99	1-3/8	1-1/4	1-14
AQ83-DOT-8X8	1/2	1/2	1.99	1-3/8	1-1/4	1-14
AQ83-DOT-10X8	5/8	1/2	2.33	1-3/8	1-1/4	1-14

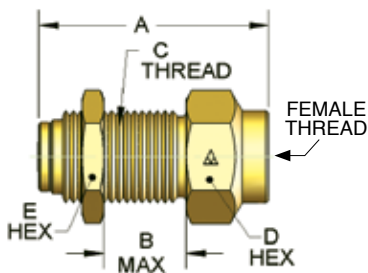

AQ86-DOT FEMALE BULKHEAD UNION

Part Number	Tube O.D.	Female Pipe	A	B	C	D	E
AQ86-DOT-4X2	1/4	1/8	1.32	0.64	1/2-20	11/16	11/16
AQ86-DOT-4X4	1/4	1/4	1.56	0.64	1/2-20	11/16	11/16
AQ86-DOT-6X4	3/8	1/4	1.87	1.00	3/4-16	15/16	15/16
AQ86-DOT-6X6	3/8	3/8	1.87	1.00	3/4-16	15/16	15/16
AQ86-DOT-8X6	1/2	3/8	2.04	1.00	15/16-16	1-1/8	1 3/8

* Made to Order – consult factory for price and availability.



SERIES MAQ

METRIC BRASS PUSH-IN INDUSTRIAL FITTINGS

In industrial applications, we know reliability is what you need, and Alkon customers know they'll get it. We make Series MAQ fittings to precise specifications with high-grade brass and specially formulated thread sealant for your application requirements.

ALKON SERIES MAQ FITTINGS ARE:

- ◆ Made here, from raw brass bars to final assembly for total quality control
- ◆ Available in nickel-plated CA 360 and CA 377 brass for high gloss and corrosion resistance
- ◆ Engineered and tested to ensure maximum flow, easy installation and the most reliable airtight seal



ALKON FEATURE	YOUR BENEFIT
Positive seal; more tube support area beyond the O-ring than competing products	Compensates for bias-cut tubing, cuts troubleshooting time dramatically
Swivel elbows and tees	Easier close center-line installation, no orientation problems
Custom part orders are welcome	Get and pay for exactly what you need – nothing more, nothing less

SERIES MAQ

METRIC BRASS PUSH-IN INDUSTRIAL FITTINGS

SPECIFICATIONS

Temperature Range:	-20°F to 220°F
Threads:	BSPT
Recommended Tubing:	Nylon

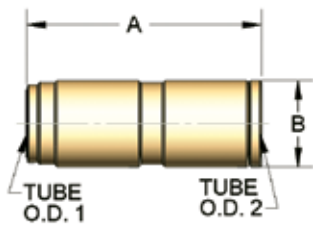

MAQ56-P TUBE TO TUBE UNION REDUCER

Part Number	Tube O.D. 1	Tube O.D. 2	A	B
MAQ56-P-4MX5/32*	4mm	5/32	1.18	11.1
MAQ56-P-6MX4*	6mm	1/4	1.43	14.3
MAQ56-P-8MX4*	8mm	1/4	1.53	14.3
MAQ56-P-8MX6*	8mm	3/8	1.58	14.3
MAQ56-P-10MX6*	10mm	3/8	1.58	18.3
MAQ56-P-12MX8*	12mm	1/2	1.73	20.6

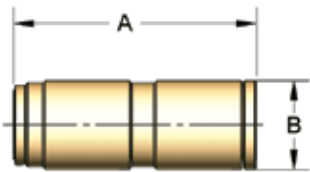

MAQ62-P UNION

Part Number	Tube O.D.	A	B
MAQ62-P-4	4mm	29.7	11.2
MAQ62-P-6	6mm	32.0	14.2
MAQ62-P-8	8mm	36.8	14.3
MAQ62-P-10	10mm	36.8	18.3
MAQ62-P-12	12mm	38.4	20.2

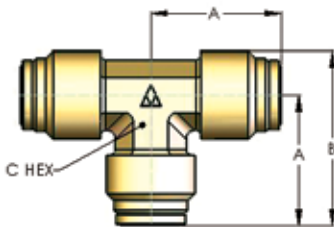

MAQ64-P UNION TEE

Part Number	Tube O.D.	A	B	C
MAQ64-P-4*	4mm	16.7	16.7	7.9
MAQ64-P-6	6mm	20.8	20.8	9.5
MAQ64-P-8	8mm	24.1	24.1	11.1
MAQ64-P-10*	10mm	24.7	24.7	12.7
MAQ64-P-12*	12mm	30.5	30.5	15.9

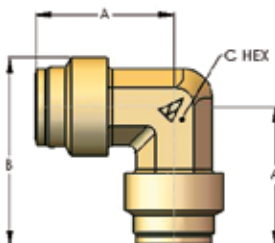

MAQ65-P UNION ELBOW

Part Number	Tube O.D.	A	B	C
MAQ65-P-6	6mm	21.6	28.0	9.5
MAQ65-P-8	8mm	24.1	32.4	11.1

* Made to Order – consult factory for price and availability.

SERIES MAQ

METRIC BRASS PUSH-IN METRIC INDUSTRIAL FITTINGS

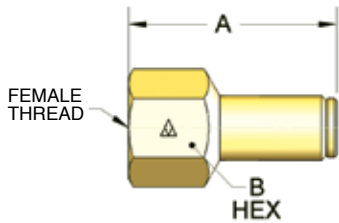

MAQ66-P FEMALE CONNECTOR

Part Number	Tube O.D.	Female Pipe	A	B
MAQ66-P-4X2*	4mm	1/8	28.2	14.0
MAQ66-P-4X4*	4mm	1/4	35.2	32.0
MAQ66-P-6X2*	6mm	1/8	33.0	29.5
MAQ66-P-6X4*	6mm	1/4	33.5	19.0
MAQ66-P-8X4*	8mm	1/4	33.5	19.0
MAQ66-P-8X6*	8mm	3/8	39.5	36.0

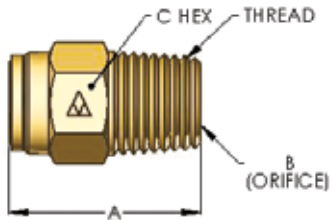

MAQ68-P MALE CONNECTOR

Part Number	Tube O.D.	Pipe (BSPT)	A	B	C
MAQ68-P-4X2*	4mm	1/8	18.6	3.5	11.0
MAQ68-P-4X4*	4mm	1/4	23.1	3.5	14.0
MAQ68-P-6X2	6mm	1/8	21.5	5.1	14.0
MAQ68-P-6X4	6mm	1/4	23.1	5.1	14.0
MAQ68-P-8X4	8mm	1/4	25.9	6.0	14.0
MAQ68-P-8X6*	8mm	3/8	24.5	6.0	19.0
MAQ68-P-10X4*	10mm	1/4	31.2	7.9	18.0
MAQ68-P-10X6*	10mm	3/8	31.2	7.9	18.0
MAQ68-P-12X4	12mm	1/4	32.0	7.9	18.0
MAQ68-P-12X6*	12mm	3/8	32.0	9.0	18.0
MAQ68-P-12X8*	12mm	1/2	30.7	10.3	22.0

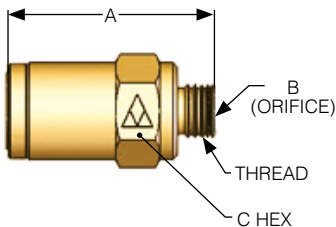

MAQ68-P MALE CONNECTOR WITH "G" THREADS

Part Number	Tube O.D.	Pipe Thread (BSPP)	A	B	C
MAQ68-P-4X0G*	4mm	M5	19.8	2.3	9
MAQ68-P-4X2G*	4mm	1/8	18.4	3.5	14
MAQ68-P-4X4G*	4mm	1/4	19.8	3.5	19
MAQ68-P-6X0G*	6mm	M5	21.6	2.3	12
MAQ68-P-6X2G*	6mm	1/8	20.0	3.5	14
MAQ68-P-6X4G*	6mm	1/4	21.6	5.1	19
MAQ68-P-8X4G*	8mm	1/4	21.6	6.0	19
MAQ68-P-8X6G*	8mm	3/8	24.1	7.1	22
MAQ68-P-10X4G*	10mm	1/4	26.3	7.9	18
MAQ68-P-10X6G*	10mm	3/8	23.2	7.9	22
MAQ68-P-12X4G*	12mm	1/4	27.1	7.9	18

* Made to Order – consult factory for price and availability.

SERIES MAQ

METRIC BRASS PUSH-IN METRIC INDUSTRIAL FITTINGS

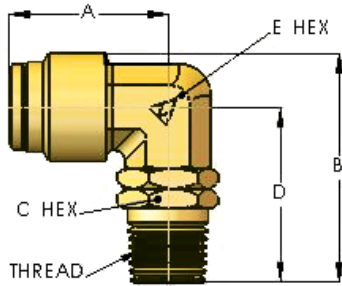

MAQ69-PS SWIVEL MALE ELBOW

Part Number	Tube O.D.	Pipe (BSPT)	A	B	C	D	E
MAQ69-PS-4X2	4mm	1/8	17.0	22.1	11.0	28.2	9.5
MAQ69-PS-4X4	4mm	1/4	17.0	26.3	14.0	32.4	9.5
MAQ69-PS-6X2	6mm	1/8	20.9	22.4	11.0	29.3	9.5
MAQ69-PS-6X4	6mm	1/4	21.7	27.1	14.0	34.0	9.5
MAQ69-PS-8X4	8mm	1/4	24.0	29.3	14.0	37.6	11.0
MAQ69-PS-8X6	8mm	3/8	24.0	29.9	19.0	38.2	11.0
MAQ69-PS-10X4	10mm	1/4	24.3	29.6	14.0	38.5	12.7
MAQ69-PS-10X6	10mm	3/8	24.3	31.8	19.0	39.9	12.7
MAQ69-PS-12X6	12mm	3/8	26.5	32.5	19.0	42.2	15.9
MAQ69-PS-12X8	12mm	1/2	26.5	37.8	22.0	47.8	15.9

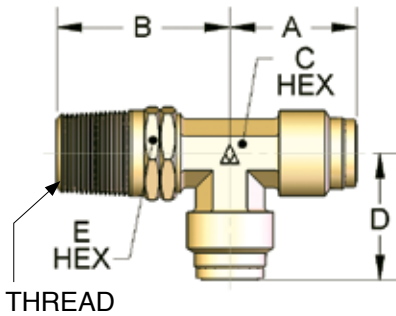

MAQ71-PS SWIVEL MALE RUN TEE

Part Number	Tube O.D.	Pipe (BSPT)	A	B	C	D	E
MAQ71-PS-4X2*	4mm	1/8	19.7	16.5	11.0	29.7	11.0
MAQ71-PS-4X4*	4mm	1/4	19.7	16.5	14.0	34.7	14.0
MAQ71-PS-6X2*	6mm	1/8	26.0	22.5	11.0	28.7	11.0
MAQ71-PS-6X4*	6mm	1/4	26.0	22.5	14.0	33.7	14.0
MAQ71-PS-8X4*	8mm	1/4	27.5	24.0	14.0	35.2	14.0
MAQ71-PS-8X6*	8mm	3/8	27.5	24.0	18.0	35.2	19.0
MAQ71-PS-10X4*	10mm	1/4	27.0	23.5	14.0	35.2	14.0
MAQ71-PS-10X6*	10mm	3/8	27.0	23.5	18.0	35.2	19.0
MAQ71-PS-12X6*	12mm	3/8	30.0	26.5	18.0	37.0	19.0

Never Settle for Less

Our production equipment combines the latest CNC technologies with equipment we customized or built from the ground up to meet our strict quality standards. If we can build our own machines, you know we can make a custom fitting for you.



* Made to Order – consult factory for price and availability.

SERIES MAQ

METRIC BRASS PUSH-IN METRIC INDUSTRIAL FITTINGS

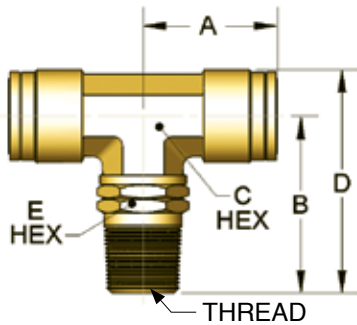

MAQ72-PS SWIVEL MALE BRANCH TEE

Part Number	Tube O.D.	Pipe (BSPT)	A	B	C	D	E
MAQ72-PS-4X2*	4mm	1/8	19.2	16.0	11.0	29.7	11.0
MAQ72-PS-4X4*	4mm	1/4	19.2	16.0	14.0	34.7	14.0
MAQ72-PS-6X2*	6mm	1/8	26.0	22.5	11.0	31.2	11.0
MAQ72-PS-6X4*	6mm	1/4	26.0	22.5	14.0	36.2	14.0
MAQ72-PS-8X4*	8mm	1/4	27.0	23.5	14.0	36.7	14.0
MAQ72-PS-8X6*	8mm	3/8	27.0	23.5	18.0	36.7	19.0
MAQ72-PS-10X4*	10mm	1/4	27.5	24.0	14.0	35.5	14.0
MAQ72-PS-10X6*	10mm	3/8	27.5	24.0	18.0	37.5	19.0

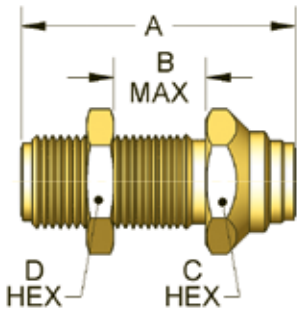

MAQ82-P BULKHEAD UNION

Part Number	Tube O.D.	A	B	C	D	E
MAQ82-P-4	4mm	36.5	12.7	16.0	16.0	7/16-20
MAQ82-P-6	6mm	39.2	22.6	17.0	17.0	5/8-18
MAQ82-P-8	8mm	43.9	22.6	20.0	20.0	5/8-18
MAQ82-P-10	10mm	43.9	22.6	20.0	20.0	3/4-16
MAQ82-P-12	12mm	46.6	19.0	28.5	28.5	1 5/16-16

Viton® O-Ring Seals in Series MAQ Fittings

Viton® seals are available from stock in a selected assortment of parts and can be installed in any Series MAQ fitting.

To order, just replace "P" or "PS" in series MAQ part number with "V" or "VS."

Consult Alkon for availability of AFLAS, EPR, EPDM and other O-ring seals in Series MAQ fittings.

Viton® is a registered trademark of DuPont Dow Elastomers.

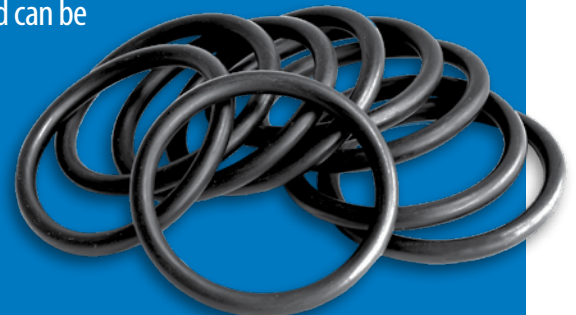

* Made to Order – consult factory for price and availability.



SERIES MAQ-DOT

METRIC AIR BRAKE BRASS
PUSH-IN FITTINGS

Alkon Series MAQ-DOT fittings are used in construction and agricultural equipment, public transit, and other industrial machines on six continents.

ALKON SERIES MAQ-DOT FITTINGS ARE:

- ◆ Designed to provide the same high performance and time savings as all Alkon push-in fittings
- ◆ Available in nickel-plated brass and brass



ALKON FEATURE	YOUR BENEFIT
Positive seal; more tube support area beyond the O-ring than competing products	Compensates for bias-cut tubing, cuts troubleshooting time dramatically
Swivel elbows and tees	Easier close center-line installation, no orientation problems
Sealant (LOCTITE® 516 standard; others available) pre-applied to all MAQ Series male threads	No charge
Custom part orders are welcome	Get and pay for exactly what you need – nothing more, nothing less

LOCTITE® is a trademark of Henkel Corporation, U.S.A.

SERIES MAQ-DOT

METRIC AIR BRAKE BRASS PUSH-IN FITTINGS

SPECIFICATIONS

Temperature Range: -40°F to 220°F

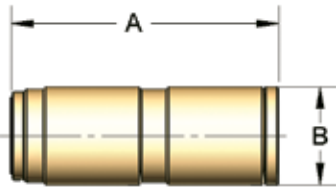

MAQ62-DOT UNION CONNECTOR

Part Number	Tube O.D. 1	A	B
MAQ62-DOT-4	4mm	38.4	9.7
MAQ62-DOT-6	6mm	40.1	11.9
MAQ62-DOT-8	8mm	40.1	14.2
MAQ62-DOT-10	10mm	40.1	17.3
MAQ62-DOT-12	12mm	40.1	19.8

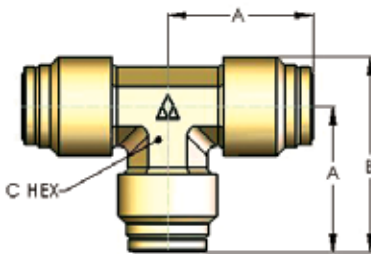

MAQ64-DOT UNION TEE

Part Number	Tube O.D.	A	B	C	D
MAQ64-DOT-6	6mm	21.6	21.6	9.5	27.7
MAQ64-DOT-8	8mm	24.4	24.4	12.7	32.6
MAQ64-DOT-10	10mm	24.4	24.4	12.7	32.6
MAQ64-DOT-12	12mm	25.4	25.4	15.9	35.6

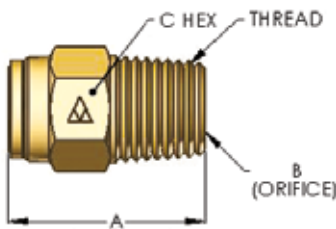

MAQ68-DOT MALE CONNECTOR

Metric Tube NPTF Thread

Part Number	Tube O.D.	Pipe (NPTF)	A	B	C
MAQ68-DOT-6X2	6mm	1/8	23.4	3.6	11.1
MAQ68-DOT-6X4	6mm	1/4	24.6	3.6	14.3
MAQ68-DOT-8X2	8mm	1/8	25.7	3.6	14.3
MAQ68-DOT-8X4	8mm	1/4	26.7	5.5	14.3
MAQ68-DOT-8X6	8mm	3/8	26.8	5.5	17.5
MAQ68-DOT-10X4	10mm	1/4	29.2	7.1	17.5
MAQ68-DOT-10X6	10mm	3/8	29.3	7.1	17.5
MAQ68-DOT-12X4	12mm	1/4	32.3	7.9	17.5
MAQ68-DOT-12X6	12mm	3/8	27.7	9.5	17.5

SERIES MAQ-DOT

METRIC AIR BRAKE BRASS PUSH-IN FITTINGS

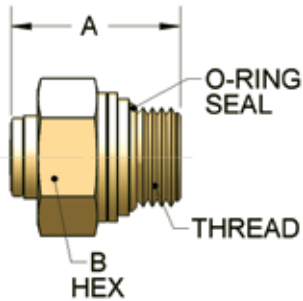

MAQ68-DOT MALE CONNECTOR

Metric Tube Metric Thread

Part Number	Tube O.D.	Metric Thread	A	B
MAQ68-DOT-6XM12	6mm	M12	28.8	17.0
MAQ68-DOT-6XM16	6mm	M16	25.6	22.0
MAQ68-DOT-6XM22	6mm	M22	25.6	27.0
MAQ68-DOT-8XM12	8mm	M12	30.0	17.0
MAQ68-DOT-8XM16	8mm	M16	28.1	22.0
MAQ68-DOT-8XM22	8mm	M22	28.1	27.0
MAQ68-DOT-10XM12	10mm	M12	30.68	17.0
MAQ68-DOT-10XM16	10mm	M16	29.3	22.0
MAQ68-DOT-10XM22	10mm	M22	27.4	27.0

SHAPE CONFIGURATION CHART:

Use the following chart as a guide when placing your order for the Series MAQ-DOT 69, 71, and 72 Metric Air Brake Brass Push-In Fittings.

MAQ

-DOTS-

X

SHAPE	
69	Male Elbow
71	Male Run Tee

TUBE SIZE	
4	4mm
6	6mm
8	8mm
10	10mm
12	12mm

THREAD	
M	Metric Straight w/Original Seal
S	Standard NPTF
Blank	Metric BSPT

THREAD	
12	M12 x 1.5
16	M16 x 1.5
22	M22 x 1.5
2	1/8"
4	1/4"
6	3/8"
8	1/2"

Dimensional data available upon request.

SERIES MAQ-DOT

METRIC AIR BRAKE BRASS PUSH-IN FITTINGS

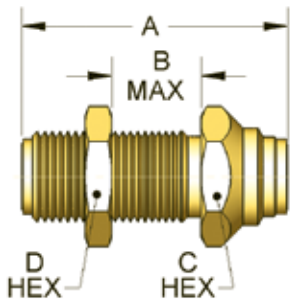

MAQ82-DOT BULKHEAD UNION

Metric Tube Metric Thread

Part Number	Tube O.D.	A	B	C	D	E
MAQ82-DOT-4*	4mm	36.5	12.7	15.8	15.8	7/16-20
MAQ82-DOT-6*	6mm	39.2	22.6	17.5	17.5	1/2-20
MAQ82-DOT-8*	8mm	43.9	22.6	20.6	20.6	5/8-19
MAQ82-DOT-10*	10mm	43.9	22.6	20.6	20.6	3/4-16
MAQ82-DOT-12	12mm	43.9	22.6	28.6	28.6	15/16-16

*Made to Order — consult factory for price and availability.

GENERAL ORDERING GUIDE:

Use this chart as a guide when placing your order for any series Brass Push-In Fittings.

1. Choose Series AQ, XQ, or MAQ configurations.
2. Choose the shape of the configuration from assigned part number.
3. Choose the style of the configuration.
4. Choose the tube size based on fractional or metric measurements of the configuration.
5. Choose the thread size based on fractional or metric measurements of the configuration.

SERIES
AQ or XQ

SHAPE

STYLES

TUBE SIZE

THREAD

- - X

SERIES
MAQ

SHAPE

STYLES

TUBE SIZE

THREAD

- - X

SHAPE

Use the assigned part number here.

STYLES

P	Non-Swivel
PS	Swivel
DOT	DOT – Non-Swivel
DOTS	DOT – Swivel
N [†]	Nickel Plated Brass (can be added to any fitting)

[†]Minimum quantity may apply.

TUBE SIZE Fractional

2	1/8"
5/32	5/32"
4	1/4"
6	3/8"
8	1/2"
10	5/8"
12	3/4"

TUBE SIZE Metric

4	4 mm
6	6 mm
8	8 mm
10	10 mm
12	12 mm

THREAD NPTF Fractional

0	10/32"
2	1/8"
4	1/4"
6	3/8"
8	1/2"

THREAD BSPT Fractional

2R	1/8"
4R	1/4"
6R	3/8"
8R	1/2"

THREAD (O-Ring Seal) Metric

M12	M12 x 1.5
M16	M16 x 1.5
M22	M22 x 1.5

BSPP PIPE THREADS

0G	M5
2G	1/8" BSPP
4G	1/4" BSPP
6G	3/8" BSPP
8G	1/2" BSPP

Metric shapes only available in swivels.



SERIES AP

BRASS TUBE FITTINGS FOR PLASTIC TUBING

Make the most of every fitting you buy with Alkon Series AP tube fittings. These fittings are specifically designed for reuse – even the tubing – to keep working from one job to the next.

ALKON SERIES AP FITTINGS ARE:

- ◆ Built with reusable components, even tubing; connect/disconnect multiple times
- ◆ Compatible with a variety of tubing materials to meet any application requirements
- ◆ The fittings of choice for critical pneumatic manufacturing processes, motion controls and many special applications
- ◆ Engineered and tested to ensure maximum flow, easy installation and the most reliable airtight seal



ALKON FEATURE	YOUR BENEFIT
Full range of configurations, O.D., sizes and threads	Get the right fit for every connection
Chrome-plated brass couplers and shut-offs	Extra-durable and well suited to systems involving food processing, refrigeration, and reactants
Testing for precision and performance in our custom testing lab	Get airtight performance you can count on
Custom part orders are welcome	Get and pay for exactly what you need – nothing more, nothing less

SERIES AP

BRASS TUBE FITTINGS FOR PLASTIC TUBING

SPECIFICATIONS

Temperature Range Nylon Sleeve:	-40° F to 225° F	Material of Straights:	Brass CA 360
Temperature Range Brass Sleeve:	-40° F to 325° F	Material of Sleeves:	Brass/Nylon
Material of Shapes (Elbow, Tees):	Brass CA 377	Compatible Tubing:	Soft Metal, Polyethylene, Nylon

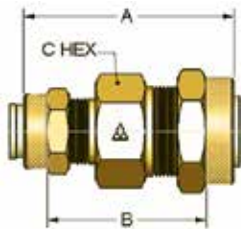

AP56-P REDUCING UNION

Part Number	Tube O.D.	A	B	C
AP56-P-6X4	3/8X1/4	1.263	0.895	9/16
AP56-P-8X6*	1/2X3/8	1.637	1.244	3/4

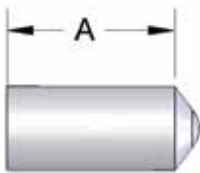

AP59-P CAP

Part Number	Tube O.D.	A
AP59-P-4	1/4	0.500
AP59-P-5*	5/16	0.531
AP59-P-6	3/8	0.562
AP59-P-8*	1/2	0.593



AP60-P PLASTIC SLEEVE

Part Number	Tube O.D.	A
AP60-P-4	1/4	0.322
AP60-P-5	5/16	0.340
AP60-P-6	3/8	0.358
AP60-P-8	1/2	0.400

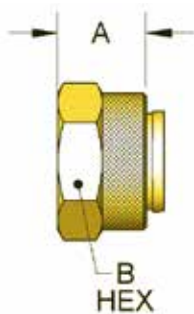

AP61-B UNIVERSAL NUT AND BRASS SLEEVE ASSEMBLY

Part Number	Tube O.D.	A	B	Thread
AP61-B-2	1/8	0.375	3/8	5/16-24
AP61-B-3	3/16	0.406	7/16	3/8-24
AP61-B-4	1/4	0.343	7/16	3/8-24
AP61-B-5	5/16	0.343	1/2	7/16-24
AP61-B-6	3/8	0.375	9/16	1/2-24
AP61-B-8	1/2	0.421	13/16	11/16-20

* Made to Order – consult factory for price and availability.

SERIES AP

BRASS TUBE FITTINGS FOR PLASTIC TUBING

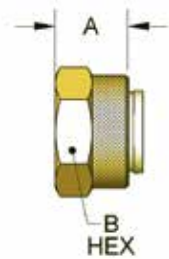

AP61-P NUT AND PLASTIC SLEEVE ASSEMBLY

Part Number	Tube O.D.	A	B	Thread
AP61-P-4	1/4	0.345	7/16	3/8-24
AP61-P-5	5/16	0.343	1/2	7/16-24
AP61-P-6	3/8	0.365	9/16	1/2-24
AP61-P-8	1/2	0.428	13/16	11/16-20

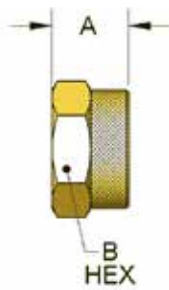

AP61-U NUT ONLY

Part Number	Tube O.D.	A	B	Thread
AP61-U-2	1/8	0.375	3/8	5/16-24
AP61-U-3*	3/16	0.406	7/16	3/8-24
AP61-U-4	1/4	0.345	7/16	3/8-24
AP61-U-5	5/16	0.355	1/2	7/16-24
AP61-U-6	3/8	0.365	9/16	1/2-24
AP61-U-8	1/2	0.428	13/16	11/16-20

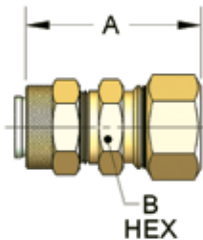

AP62-C UNION TUBE - TO COMPRESSION

Part Number	Tube O.D.	A	B
AP62-C-4*	1/8	1.250	7/16
AP62-C-5*	5/16	1.281	1/2
AP62-C-6*	3/8	1.406	9/16

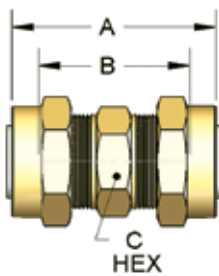

AP62-P UNION

Part Number	Tube O.D.	A	B
AP62-P-2	1/8	1.277	5/16
AP62-P-3	3/16	1.328	7/16
AP62-P-4	1/4	1.241	7/16
AP62-P-5	5/16	1.248	1/2
AP62-P-6	3/8	1.241	9/16
AP62-P-8	1/2	1.601	3/4

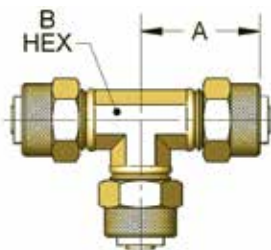

AP64-P UNION

Part Number	Tube O.D.	A	B
AP64-P-2	1/8	0.825	5/16
AP64-P-3	3/16	0.835	5/16
AP64-P-4	1/4	0.766	5/16
AP64-P-5	5/16	0.915	3/8
AP64-P-6	3/8	0.802	3/8
AP64-P-8	1/2	1.14	5/8

* Made to Order – consult factory for price and availability.

SERIES AP

BRASS TUBE FITTINGS FOR PLASTIC TUBING

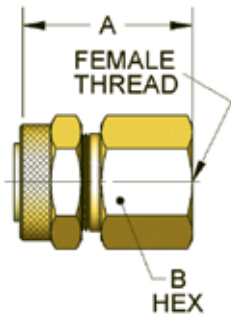

AP66-P FEMALE CONNECTOR

Part Number	Tube O.D.	Female Pipe	A	B
AP66-P-2X2*	1/8	1/8	1.045	9/16
AP66-P-3X2*	3/16	1/8	1.060	9/16
AP66-P-3X4*	3/16	1/4	1.265	11/16
AP66-P-4X2*	1/4	1/8	1.020	1/2
AP66-P-4X4	1/4	1/4	1.207	5/8
AP66-P-4X6*	1/4	3/8	1.272	7/8
AP66-P-5X2	5/16	1/8	1.200	1/2
AP66-P-6X4	3/8	1/4	1.177	5/8
AP66-P-8X6	1/2	3/8	1.350	13/16

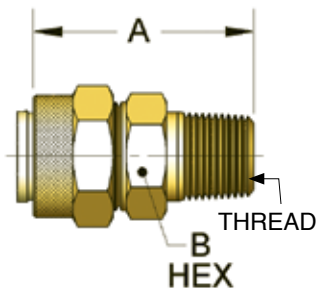

AP68-P MALE CONNECTOR

Part Number	Tube O.D.	Pipe	A	B
AP68-P-2X0*	1/8	10/32**	0.878	5/16
AP68-P-2X2	1/8	1/8	1.124	7/16
AP68-P-3X2	3/16	1/8	1.133	7/16
AP68-P-4X0	1/4	10/32**	0.864	3/8
AP68-P-4X2	1/4	1/8	1.057	7/16
AP68-P-4X4	1/4	1/4	1.267	9/16
AP68-P-4X6	1/4	3/8	1.332	11/16
AP68-P-5X2	5/16	1/8	1.123	1/2
AP68-P-5X4	5/16	1/4	1.292	9/16
AP68-P-6X2	3/8	1/8	1.083	9/16
AP68-P-6X4	3/8	1/4	1.271	9/16
AP68-P-6X6	3/8	3/8	1.271	11/16
AP68-P-8X4*	1/2	1/4	1.343	
AP68-P-8X6	1/2	3/8	1.443	11/16
AP68-P-8X8	1/2	1/2	1.674	7/8

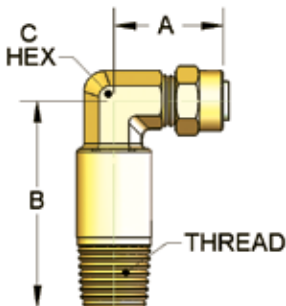

AP69-L EXTRA-LONG MALE ELBOW

Part Number	Tube O.D.	Pipe	A	B	C
AP69-L-4X4	1/4	1/4	0.834	1.500	3/8

* Made to Order – consult factory for price and availability.

** Furnished with nylon gasket.

SERIES AP

BRASS TUBE FITTINGS FOR PLASTIC TUBING

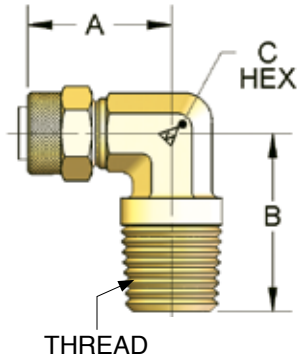

AP69-P MALE ELBOW

Part Number	Tube O.D.	Pipe	A	B	C
AP69-P-2X2	1/8	1/8	0.800	0.689	5/16
AP69-P-3X2	3/16	1/8	0.809	0.690	3/8
AP69-P-4X1*	1/4	1/16	0.830	0.625	0.375
AP69-P-4X2	1/4	1/8	0.830	0.748	3/8
AP69-P-4X4	1/4	1/4	0.882	0.958	3/8
AP69-P-4X6	1/4	3/8	0.954	0.984	1/2
AP69-P-5X2	5/16	1/8	0.894	0.750	3/8
AP69-P-6X2	3/8	1/8	0.865	0.750	3/8
AP69-P-6X4	3/8	1/4	0.943	1.053	1/2
AP69-P-6X6	3/8	3/8	0.912	0.984	1/2
AP69-P-8X6	1/2	3/8	1.197	1.006	5/8
AP69-P-8X8	1/2	1/2	1.197	1.196	5/8

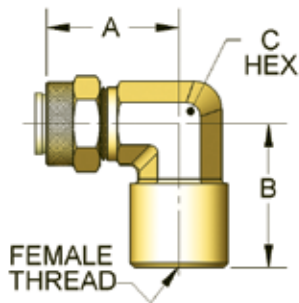

AP70-P FEMALE ELBOW

Part Number	Tube O.D.	Female Pipe	A	B	C
AP70-P-2X2	1/8	1/8	0.900	0.750	3/8
AP70-P-3X2	3/16	1/8	0.905	0.750	3/8
AP70-P-4X2	1/4	1/8	0.889	0.867	3/8
AP70-P-4X4	1/4	1/4	0.970	1.025	1/2
AP70-P-6X4	3/8	1/4	0.960	1.000	1/2
AP70-P-8X6	1/2	3/8	1.140	1.062	5/8

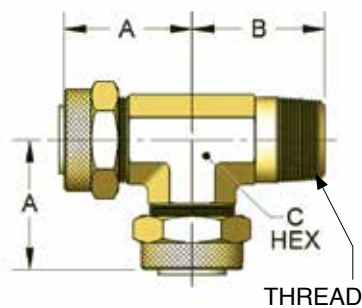

AP71-P MALE RUN TEE

Part Number	Tube O.D.	Pipe	A	B	C
AP71-P-2X2*	1/8	1/8	0.825	0.655	5/16
AP71-P-3X2*	3/16	1/8	0.835	0.655	5/16
AP71-P-4X2*	1/4	1/8	0.895	0.750	3/8
AP71-P-4X4	1/4	1/4	0.926	0.937	7/16
AP71-P-5X2*	5/16	1/8	0.895	0.750	3/8
AP71-P-6X4	3/8	1/4	0.908	0.949	7/16
AP71-P-8X6*	1/2	3/8	1.140	1.052	5/8

* Made to Order – consult factory for price and availability.

SERIES AP

BRASS TUBE FITTINGS FOR PLASTIC TUBING

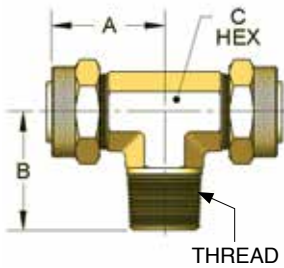

AP72-P MALE BRANCH TEE

Part Number	Tube O.D.	Pipe	A	B	C
AP72-P-2X2*	1/8	1/8	0.825	0.700	5/16
AP72-P-3X2*	3/16	1/8	0.835	0.700	5/16
AP72-P-4X2	1/4	1/8	0.895	0.750	3/8
AP72-P-4X4	1/4	1/4	0.927	0.897	7/16
AP72-P-5X2*	5/16	1/8	0.904	0.745	3/8
AP72-P-6X2	3/8	1/8	0.859	0.750	7/16
AP72-P-6X4	3/8	1/4	0.908	0.897	7/16
AP72-P-8X6*	1/2	3/8	1.140	1.052	5/8

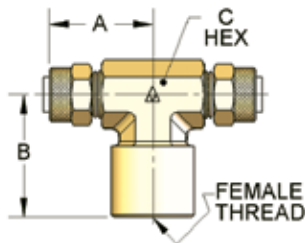

AP77-P FEMALE BRANCH TEE

Part Number	Tube O.D.	Female Pipe	A	B	C
AP77-P-4X2*	1/4	1/8	0.771	0.937	7/16
AP77-P-4X4*	1/4	1/4	0.940	0.984	1/2
AP77-P-4X6*	1/4	3/8	0.893	1.125	5/8

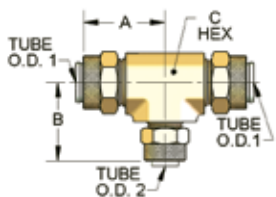

AP79-P UNION REDUCING TEE REDUCING ON BRANCH

Part Number	Tube O.D. 1	Tube O.D. 2	A	B	C
AP79-P-6X4	3/8	1/4	0.802	0.896	3/8

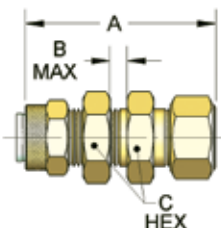

AP82-C BULKHEAD UNION - TO STANDARD COMPRESSION

Part Number	Tube O.D.	A	B	C
AP82-C-4	1/4	1.796	0.375	0.562
AP82-C-6*	3/8	2.000	0.375	0.687

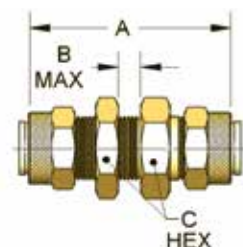

AP82-P BULKHEAD UNION

Part Number	Tube O.D.	A	B	C
AP82-P-4	1/4	1.790	0.312	9/16
AP82-P-5*	5/16	1.790	0.312	5/8
AP82-P-6	3/8	1.792	0.375	11/16
AP82-P-8*	1/2	2.262	0.375	7/8

* Made to Order – consult factory for price and availability.

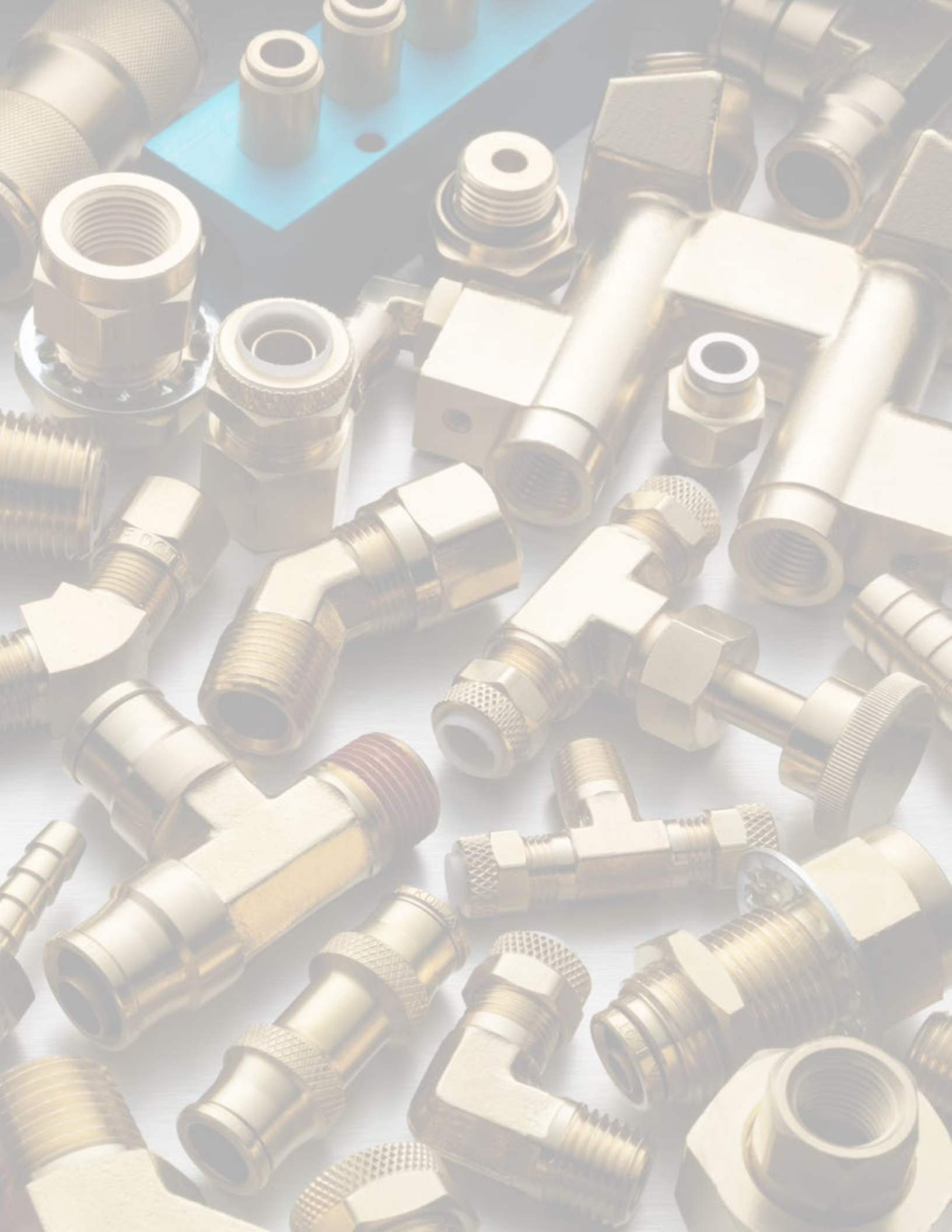



SERIES XQ-DOT

AIR BRAKE BRASS PUSH-IN FITTINGS

Alkon Series XQ-DOT air brake brass push-in fittings hold up better in extreme temperatures from blistering heat to numbing cold. Better chemical resistance helps protect against early failure.

ALKON SERIES XQ-DOT FITTINGS ARE:

- ◆ Able to withstand temperature extremes from -40°F to 400°F
- ◆ Made with higher grade thread sealant resists chemical attack, corrosion, vibration and thermal shock for a longer lasting tight seal
- ◆ Designed for OTR vehicles, such as heavy machinery, agricultural/ construction equipment, public transit and oil/gas industry applications



ALKON FEATURE	YOUR BENEFIT
Positive seal; more tube support area beyond the O-ring than competing products	Compensates for bias-cut tubing, cuts troubleshooting time dramatically
Swivel elbows and tees	Easier close center-line installation, no orientation problems
Fixed elbows and tees	Great performance and great economy
Sealant (ST-3® standard; others available) pre-applied to all XQ-DOT Series male threads	No charge

ST-3® is a trademark of ND Industries.

SERIES XQ-DOT

AIR BRAKE BRASS PUSH-IN FITTINGS

SPECIFICATIONS

Temperature Range: -40° F to 400° F
 Threads: NPTF Standard
 Recommended Tubing: J844 Air Brake Tubing

Air Brake Performance Requirements:
 Brass:

D.O.T. FMVSS 571.106 / SAE J1131 / J2494-1 & J2494-3
 CA360 & CA377

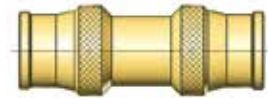

XQ54 45° MALE ELBOW

Part Number	Tube O.D.	Male Pipe
XQ54-DOT-4X2	1/4	1/8
XQ54-DOT-4X4	1/4	1/4
XQ54-DOT-6X2	3/8	1/8
XQ54-DOT-6X4	3/8	1/4
XQ54-DOT-6X6	3/8	3/8
XQ54-DOT-6X8	3/8	1/2
XQ54-DOT-8X4	1/2	1/4
XQ54-DOT-8X6	1/2	3/8
XQ54-DOT-8X8	1/2	1/2

XQ54 SWIVEL 45° MALE ELBOW

Part Number	Tube O.D.	Male Pipe
XQ54-DOTS-4X2	1/4	1/8
XQ54-DOTS-4X4	1/4	1/4
XQ54-DOTS-6X2	3/8	1/8
XQ54-DOTS-6X4	3/8	1/4
XQ54-DOTS-6X6	3/8	3/8
XQ54-DOTS-6X8	3/8	1/2
XQ54-DOTS-8X4*	1/2	1/4
XQ54-DOTS-8X6	1/2	3/8
XQ54-DOTS-8X8	1/2	1/2

XQ62 UNION CONNECTOR

Part Number	Tube O.D.
XQ62-DOT-5/32	5/32
XQ62-DOT-4	1/4
XQ62-DOT-6	3/8
XQ62-DOT-8	1/2

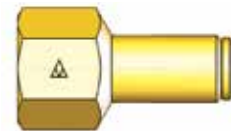
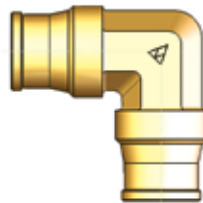

XQ64 UNION TEE

Part Number	Tube O.D.
XQ64-DOT-4	1/4
XQ64-DOT-6	3/8
XQ64-DOT-8	1/2

XQ65 UNION ELBOW

Part Number	Tube O.D.
XQ65-DOT-4	1/4
XQ65-DOT-6	3/8
XQ65-DOT-8	1/2

XQ66 FEMALE CONNECTOR

Part Number	Tube O.D.	Female Pipe
XQ66-DOT-4X2	1/4	1/8
XQ66-DOT-4X4	1/4	1/4
XQ66-DOT-6X4	3/8	1/4
XQ66-DOT-6X6	3/8	3/8
XQ66-DOT-8X6*	1/2	3/8
XQ66-DOT-8X8*	1/2	1/2

* Made to Order – consult factory for price and availability.

SERIES XQ-DOT

AIR BRAKE BRASS PUSH-IN FITTINGS

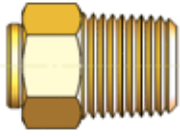

XQ68 MALE CONNECTOR		
Part Number	Tube O.D.	Male Pipe
XQ68-DOT-5/32X1	5/32	1/16
XQ68-DOT-5/32X2	5/32	1/8
XQ68-DOT-4X1	1/4	1/16
XQ68-DOT-4X2	1/4	1/8
XQ68-DOT-4X4	1/4	1/4
XQ68-DOT-4X6*	1/4	3/8
XQ68-DOT-6X2	3/8	1/8
XQ68-DOT-6X4	3/8	1/4
XQ68-DOT-6X6	3/8	3/8
XQ68-DOT-6X8	3/8	1/2
XQ68-DOT-8X4	1/2	1/4
XQ68-DOT-8X6	1/2	3/8
XQ68-DOT-8X8	1/2	1/2



XQ688 PRESS-IN CARTRIDGE	
Part Number	Tube O.D.
XQ688-DOT-5/32	5/32
XQ688-DOT-3*	3/16
XQ688-DOT-4	1/4
XQ688-DOT-6	3/8
XQ688-DOT-8*	1/2



XQ69 MALE ELBOW		
Part Number	Tube O.D.	Male Pipe
XQ69-DOT-5/32X2	5/32	1/8
XQ69-DOT-4X2	1/4	1/8
XQ69-DOT-4X4	1/4	1/4
XQ69-DOT-4X6	1/4	3/8
XQ69-DOT-6X2	3/8	1/8
XQ69-DOT-6X4	3/8	1/4
XQ69-DOT-6X6	3/8	3/8
XQ69-DOT-6X8	3/8	1/2
XQ69-DOT-8X4	1/2	1/4
XQ69-DOT-8X6	1/2	3/8
XQ69-DOT-8X8	1/2	1/2

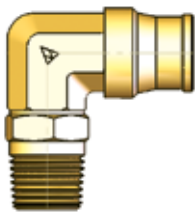

XQ69 SWIVEL MALE ELBOW		
Part Number	Tube O.D.	Male Pipe
XQ69-DOTS-5/32X2	5/32	1/8
XQ69-DOTS-5/32X4*	5/32	1/4
XQ69-DOTS-4X2	1/4	1/8
XQ69-DOTS-4X4	1/4	1/4
XQ69-DOTS-4X6	1/4	3/8
XQ69-DOTS-6X2	3/8	1/8
XQ69-DOTS-6X4	3/8	1/4
XQ69-DOTS-6X6	3/8	3/8
XQ69-DOTS-6X8	3/8	1/2
XQ69-DOTS-8X4	1/2	1/4
XQ69-DOTS-8X6	1/2	3/8
XQ69-DOTS-8X8	1/2	1/2



XQ70 SWIVEL FEMALE ELBOW		
Part Number	Tube O.D.	Female Pipe
XQ70-DOTS-4X2	1/4	1/8
XQ70-DOTS-4X4	1/4	1/4



XQ70 FEMALE ELBOW		
Part Number	Tube O.D.	Female Pipe
XQ70-DOT-4X2	1/4	1/8
XQ70-DOT-4X4	1/4	1/4
XQ70-DOT-4X6*	1/4	3/8
XQ70-DOT-6X4	3/8	1/4
XQ70-DOT-6X6	3/8	3/8

* Made to Order – consult factory for price and availability.

SERIES XQ-DOT

AIR BRAKE BRASS PUSH-IN FITTINGS



XQ72 MALE BRANCH TEE		
Part Number	Tube O.D.	Male Pipe
XQ72-DOT-4X2	1/4	1/8
XQ72-DOT-4X4	1/4	1/4
XQ72-DOT-6X4	3/8	1/4
XQ72-DOT-6X6	3/8	3/8
XQ72-DOT-8X4*	1/2	1/4
XQ72-DOT-8X6	1/2	3/8



XQ72 SWIVEL MALE BRANCH TEE		
Part Number	Tube O.D.	Male Pipe
XQ72-DOTS-4X2	1/4	1/8
XQ72-DOTS-4X4	1/4	1/4
XQ72-DOTS-6X2	3/8	1/8
XQ72-DOTS-6X4	3/8	1/4



XQ77 FEMALE BRANCH TEE		
Part Number	Tube O.D.	Female Pipe
XQ77-DOT-4X2	1/4	1/8
XQ77-DOT-4X4	1/4	1/4
XQ77-DOT-6X4	3/8	1/4
XQ77-DOT-6X6*	3/8	3/8

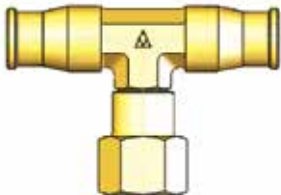

XQ77 SWIVEL FEMALE BRANCH TEE		
Part Number	Tube O.D.	Female Pipe
XQ77-DOTS-4X2*	1/4	1/8
XQ77-DOTS-4X4*	1/4	1/4

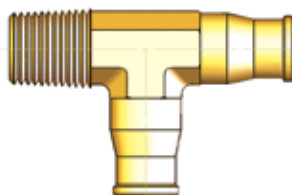

XQ71 MALE RUN TEE		
Part Number	Tube O.D.	Male Pipe
XQ71-DOT-4X2	1/4	1/8
XQ71-DOT-4X4	1/4	1/4
XQ71-DOT-6X4	3/8	1/4
XQ71-DOT-6X6	3/8	3/8

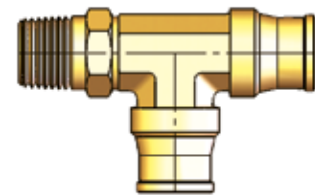

XQ71 SWIVEL MALE RUN TEE		
Part Number	Tube O.D.	Male Pipe
XQ71-DOTS-4X2	1/4	1/8
XQ71-DOTS-4X4	1/4	1/4
XQ71-DOTS-6X4	3/8	1/4
XQ71-DOTS-6X6	3/8	3/8
XQ71-DOTS-8X6	1/2	3/8
XQ71-DOTS-8X8	1/2	1/2

* Made to Order – consult factory for price and availability.

SERIES XQ-DOT

AIR BRAKE BRASS PUSH-IN FITTINGS



XQ78 REDUCING MALE RUN TEE

Part Number	Tube O.D. 1	Tube O.D. 2	Male Pipe
-------------	-------------	-------------	-----------



XQ79 UNION REDUCING TEE

Part Number	Tube O.D. 1	Tube O.D. 2
XQ79-DOT-4X6	1/4	3/8
XQ79-DOT-6X5/32	3/8	5/32
XQ79-DOT-6X4	3/8	1/4

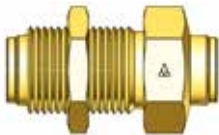

XQ82 BULKHEAD UNION

Part Number	Tube O.D. 1
XQ82-DOT-4	1/4
XQ82-DOT-6	3/8
XQ82-DOT-8	1/2

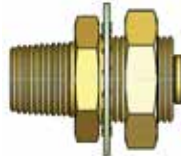

XQ83 GLADHAND MALE BULKHEAD CONNECTOR

Part Number	Tube O.D. 1	Male Pipe
XQ83-DOT-6X8*	3/8	1/2
XQ83-DOT-8X8	1/2	1/2



XQ86 FEMALE BULKHEAD UNION

Part Number	Tube O.D.	Female Pipe
XQ86-DOT-4X2	1/4	1/8
XQ86-DOT-4X4	1/4	1/4
XQ86-DOT-6X4	3/8	1/4
XQ86-DOT-6X6	3/8	3/8
XQ86-DOT-8X6	1/2	3/8



Road-Tested for Years

Alkon XQ push-in fittings have been used successfully for years in all types of extreme weather and road conditions. Due to overwhelming demand, Alkon has decided to release this product as a complete product line.

Available in union, straight, elbow and tee, both swivel and non-swivel, configurations in a wide range of sizes, Alkon XQ push-in fittings are used with standard J844 air brake tubing.

* Made to Order – consult factory for price and availability.

CUSTOMIZED FITTINGS

PRODUCTS TO FIT YOUR NEEDS



Flexibility to offer you standard “out of the catalog” components, as well as customized products to fit your needs.

We are large enough to handle any order, yet we are small enough to still be able to give you personal service.

Customized fittings are usually the result of combining other fittings such as pipe or barbs with Series AQ push-in fittings. This eliminates the number of leakage paths, reduces inventory items and saves assembly labor.

Examples shown above illustrate combinations with barbs, male and female pipe threads in the same fittings, different tube outside diameters in the same fitting, different pipe thread connections, and 45° elbows.

Contact Alkon for no-charge design assistance.

- ◆ Customized fittings are available in nickel-plated brass and brass.
- ◆ O-ring material and thread sealant options are available.
- ◆ Customized products are only limited by the imagination of the designer.



SERIES 100

PIPE FITTINGS

Alkon Series 100 pipe fittings are made to do their best work under pressure. We offer hundreds of standard sizes and configurations, and we welcome the opportunity to make a custom fitting for you.

ALKON SERIES 100 PIPE FITTINGS ARE:

- ◆ Built to function at pressures up to 3,000 PSI

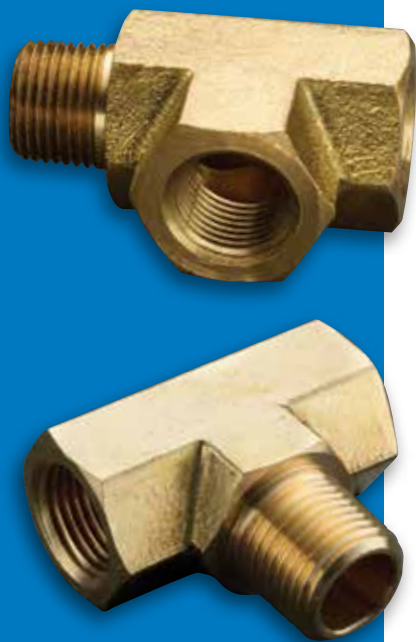

ALKON FEATURE	YOUR BENEFIT
Sophisticated technology checks critical dimensions and interior/exterior angles and concentricity to .0001"	You get the performance you deserve
Custom part orders are welcome	Get and pay for exactly what you need – nothing more, nothing less

SERIES 100

PIPE FITTINGS

SPECIFICATIONS

Pressure:	3000 PSI
Material of Shapes:	Forged SAE CA377 Brass
Material of Straights:	SAE C360 Brass

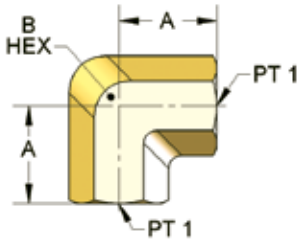

100A 90° UNION FEMALE ELBOW

Part Number	Female PT 1	Min. Orifice Size	A	B Hex
100A-2	1/8	0.328	0.546	9/16
100A-4	1/4	0.438	0.781	11/16
100A-6	3/8	0.563	0.840	15/16
100A-8	1/2	0.702	1.090	1-1/16

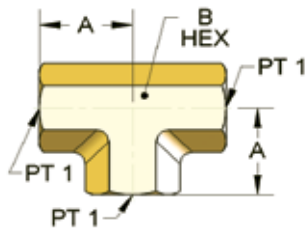

101A UNION FEMALE TEE

Part Number	Female PT 1	Min. Orifice Size	A	B Hex
101A-2	1/8	0.328	0.546	9/16
101A-4	1/4	0.438	0.781	11/16
101A-6	3/8	0.563	0.840	15/16
101A-8	1/2	0.702	1.09	1-1/16

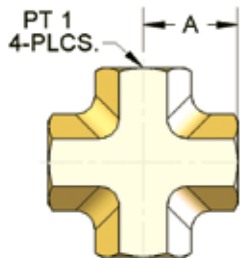

102A FEMALE CROSS

Part Number	Female PT 1	Min. Orifice Size	A	B
102A-2	1/8	0.328	0.546	9/16
102A-4	1/4	0.438	0.781	11/16
102A-6	3/8	0.563	0.840	15/16
102A-8	1/2	0.702	1.090	1-1/16

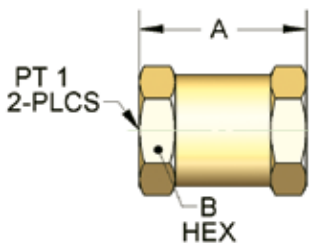

103A FEMALE COUPLING

Part Number	Female PT 1	A	CHex
103A-2	1/8	0.750	0.562
103A-4	1/4	1.120	0.750
103A-6	3/8	1.125	0.875
103A-8	1/2	1.500	1.062

NOTE: All dimensions for reference only.

SERIES 100

PIPE FITTINGS

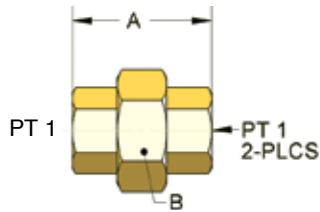

104A UNION FEMALE

Part Number	Female PT 1	Min. Orifice Size	A	B Hex
104A-2	1/8	0.44	1.265	15/16
104A-4	1/4	0.56	1.468	15/16
104A-6	3/8	0.68	1.625	1-1/16

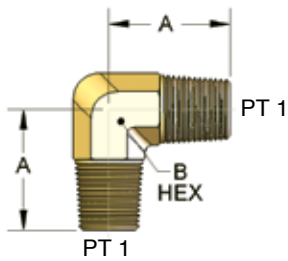

106A FORGED MALE ELBOW

Part Number	Male PT 1	A	B Hex
106A-2	1/8	0.690	5/16
106A-4	1/4	1.000	1/2
106A-6	3/8	1.060	5/8
106A-8	1/2	1.280	11/16

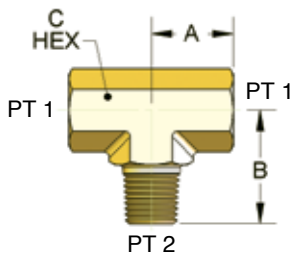

107A BRANCH TEE

Part Number	Female PT 1	Male PT 2	A	B	C
107A-2	1/8	1/8	0.55	0.82	9/16
107A-2X4	1/8	1/4	0.55	1.08	11/16
107A-4	1/4	1/4	0.78	1.08	11/16
107A-6	3/8	3/8	0.84	1.23	15/16
107A-8	1/2	1/2	1.09	1.49	1-1/16

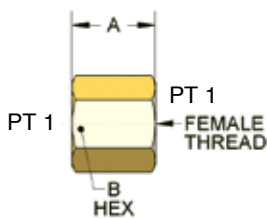

108A FEMALE CAP

Part Number	Female PT 1	A	B Hex
108A-2	1/8	0.500	0.563
108A-4	1/4	0.750	0.750
108A-6	3/8	0.875	0.875
108A-8	1/2	1.063	1.063

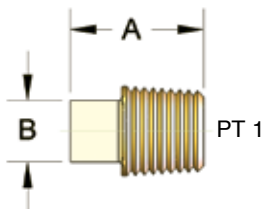

109A SQUARE-HEAD MALE PLUG

Part Number	Male PT 1	A	B Square
109A-2	1/8	0.709	9/32
109A-4	1/4	0.813	3/8
109A-6	3/8	0.849	7/16
109A-8	1/2	1.078	9/16

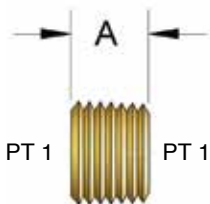

109AL COUNTERSUNK HEX-HEAD MALE PLUG

Part Number	Male PT 1	A
109AL-2	1/8	0.300
109AL-4	1/4	0.400
109AL-6	3/8	0.400
109AL-8	1/2	0.550

NOTE: All dimensions for reference only.

SERIES 100

PIPE FITTINGS

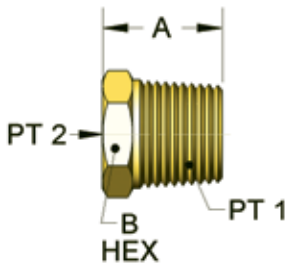

110 BUSHING

Part Number	Male PT 1	Female PT 2	Min. Orifice Size	A	B Hex
110A-4X2	1/4	1/8	0.328	0.75	9/16
110A-6X2	3/8	1/8	0.328	0.75	11/16
110A-6X4	3/8	1/4	0.438	0.75	3/4
110A-8X2	1/2	1/8	0.328	1.00	7/8
110A-8X4	1/2	1/4	0.438	1.00	7/8
110A-8X6	1/2	3/8	0.563	1.00	7/8
110A-12X4	3/4	1/4	0.438	1.00	1-1/8
110A-12X6	3/4	3/8	0.563	1.00	1-1/8
110A-12X8	3/4	1/2	0.702	1.00	1-1/8

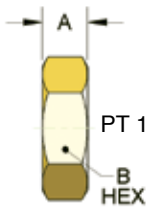

111A LOCK NUT

Part Number	PT 1	A	B Hex
111A-2	1/8	0.187	5/8
111A-4	1/4	0.250	11/16
111A-6	3/8	0.250	15/16
111A-8	1/2	0.250	1-1/8

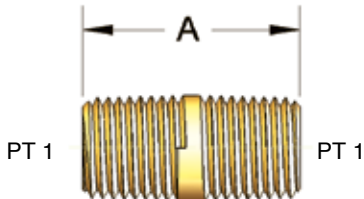

112A 90° CLOSE MALE NIPPLE

Part Number	Male PT 1	Min. Orifice Size	A
112A-2	1/8	0.281	0.750
112A-4	1/4	0.375	1.125
112A-6	3/8	0.500	1.125
112A-8	1/2	0.625	1.500
112A-12	3/4	0.750	1.500

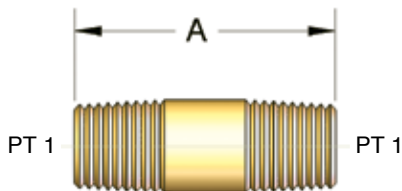

13A LONG MALE NIPPLE

Part Number	Male PT 1	Min. Orifice Size	A
113A-2X20	1/8	0.265	1-1/4
113A-2X24	1/8	0.265	1.500
113A-2X32	1/8	0.265	2.000
113A-2X40	1/8	0.265	2.500
113A-2X48	1/8	0.265	3.000
113A-2X56	1/8	0.265	3.500
113A-4X24	1/4	0.375	1.500
113A-4X32	1/4	0.375	2.000
113A-4X40	1/4	0.375	2.500
113A-4X48	1/4	0.375	3.000
113A-4X56	1/4	0.375	3.500
113A-4X64	1/4	0.375	4

Part Number	Male PT 1	Min. Orifice Size	A
113A-4X112	1/4	0.375	7
113A-6X24	3/8	0.500	1-1/2
113A-6X32	3/8	0.500	2
113A-6X40	3/8	0.500	2-1/2
113A-6X48	3/8	0.500	3
113A-6X56	3/8	0.500	3-1/2
113A-8X24	1/2	0.625	1-1/2
113A-8X32	1/2	0.625	2
113A-8X40	1/2	0.625	2-1/2
113A-8X48	1/2	0.625	3
113A-8X56	1/2	0.625	3-1/2

NOTE: All dimensions for reference only.

SERIES 100

PIPE FITTINGS

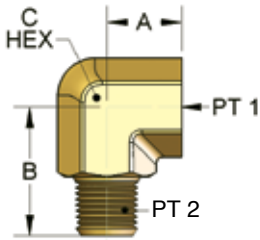

116A 90° STREET ELBOW

Part Number	Female PT 1	Male PT 2	Min. Orifice Size	A	B	C Hex
116A-2X2	1/8	1/8	0.219	0.480	0.812	9/16
116A-4X2	1/4	1/8	0.219	0.718	0.900	11/16
116A-4X4	1/4	1/4	0.312	0.718	1.031	11/6
116A-6X6	3/8	3/8	0.438	0.780	1.187	15/16
116A-8X8	1/2	1/2	0.562	1.090	1.437	1-1/16

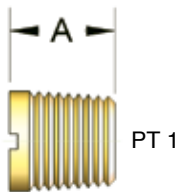

117A SLOTTED HEAD MALE PLUG

Part Number	Male PT 1	A
117A-2	1/8	0.320
117A-4	1/4	0.469

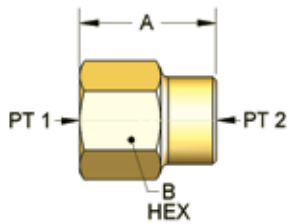

119A REDUCING FEMALE ADAPTER

Part Number	Female PT 1	Female PT 2	A	B Hex
119A-4X2	1/4	1/8	0.970	3/4
119A-6X4	3/8	1/4	1.160	7/8
119A-8X4	1/2	1/4	1.280	1-1/16
119A-8X6	1/2	3/8	1.375	1-1/16
119A-12X8	3/4	1/2	1.750	1-3/8

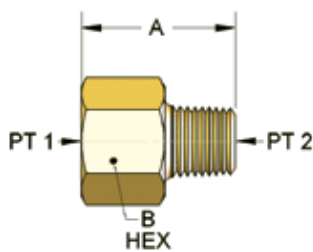

120A ADAPTER

Part Number	Female PT 1	Male PT 2	Min. Orifice Size	A	B Hex
120A-2X2	1/8	1/8	0.219	0.906	9/16
120A-4X2	1/4	1/8	0.219	1.063	3/4
120A-4X4	1/4	1/4	0.312	1.250	3/4
120A-6X2	3/8	1/8	0.219	1.070	7/8
120A-6X4	3/8	1/4	0.312	1.250	7/8
120A-6X6	3/8	3/8	0.438	1.250	7/8
120A-8X6	1/2	3/8	0.438	1.469	1-1/16
120A-8X8	1/2	1/2	0.562	1.660	1-1/16

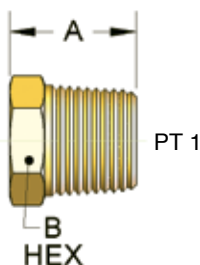

121A HEX-HEAD MALE PLUG

Part Number	Male PT 1	A	B Hex
121A-2	1/8	0.531	7/16
121A-4	1/4	0.750	9/16
121A-6	3/8	0.772	11/16
121A-8	1/2	0.969	7/8
121A-12	3/4	1.062	1-1/16

NOTE: All dimensions for reference only.

SERIES 100

PIPE FITTINGS

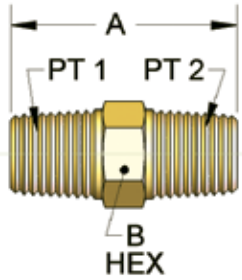

122 HEX MALE NIPPLE

Part Number	Male PT 1	Male PT 2	Min. Orifice Size	A	B Hex
122A-2X2	1/8	1/8	0.219	0.906	7/16
122A-4X2	1/4	1/8	0.219	1.190	9/16
122A-4X4	1/4	1/4	0.312	1.375	9/16
122A-6X4	3/8	1/4	0.312	1.406	11/16
122A-6X6	3/8	3/8	0.438	1.406	11/16
122A-8X4	1/2	1/4	0.312	1.620	7/8
122A-8X6	1/2	3/8	0.438	1.620	7/8
122A-8X8	1/2	1/2	0.562	1.812	7/8

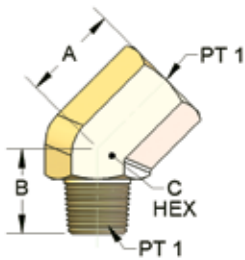

124A 45° STREET ELBOW

Part Number	PT 1	Min. Orifice Size	A	B	C Hex
124A-2X2	1/8	0.219	0.750	0.687	9/16
124A-4X4	1/4	0.312	0.875	0.781	11/16
124A-6X6	3/8	0.438	1.000	0.875	15/16
124A-8X8	1/2	0.562	1.125	1.218	1-1/16

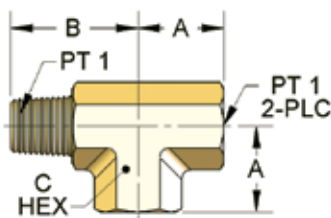

127A STREET TEE

Part Number	PT 1	Min. Orifice Size	A	B	C Hex
127A-2	1/8	0.219	0.550	0.820	9/16
127A-4	1/4	0.313	0.781	1.156	11/16
127A-6	3/8	0.438	0.840	1.230	15/16
127A-8	1/2	0.562	1.090	1.490	1-1/16

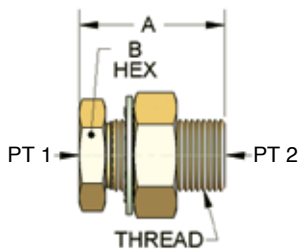

129A BULKHEAD ADAPTER

Part Number	Female PT 1	Male PT 2	Min. Orifice Size	A	B Hex
129A-2X24	1/8	5/8-18	0.328	1.500	7/8
129A-4X15	1/4	3/4-16	0.421	0.940	1"
129A-4X24	1/4	3/4-16	0.440	1.500	1"
129A-6X21	3/8	1-14	0.562	1.310	1-1/8
129A-8X24	1/2	1 1/8-14	0.700	1.500	1-1/4

NOTE: All dimensions for reference only.

SERIES 29

BARB ADAPTERS



SPECIFICATIONS

Temperature Range: -40°F to 325°F
 Material of Shapes: Forged SAE CA377 Brass
 Intended for use with: Hose Clamp (plastic tubing or rubber hose). Barb size is hose I.D.

MALE CONNECTOR

Part Number	Hose	Pipe
29-22	1/8	1/8
29-32	3/16	1/8
29-42	1/4	1/8
29-44	1/4	1/4
29-46	1/4	3/8
29-52	5/16	1/8
29-54	5/16	1/4
29-56	5/16	3/8
29-62	3/8	1/8
29-64	3/8	1/4
29-66	3/8	3/8
29-68	3/8	1/2
29-84	1/2	1/4
29-86	1/2	3/8
29-88	1/2	1/2



FEMALE CONNECTOR

Part Number	Hose	Pipe
29F-42	1/4	1/8
29F-44	1/4	1/4
29F-54	5/16	1/4
29F-64	3/8	1/4
29F-66	3/8	3/8
29F-86	1/2	3/8
29F-88	1/2	1/2



HOSE SPLICER

Part Number	Hose
29S-4	1/4
29S-5	5/16
29S-6	3/8
29S-8	1/2



MALE ELBOW FORGING

Part Number	Hose	Pipe
29E-32	3/16	1/8
29E-34	3/16	1/4
29E-42	1/4	1/8
29E-44	1/4	1/4
29E-64	3/8	1/4
29E-66	3/8	3/8
29E-84	1/2	1/4
29E-86	1/2	3/8
29E-88	1/2	1/2



Quality testing includes an optical video probe to measure critical dimensions and interior/ exterior angles and concentricity to .0001"

TUBING ACCESSORIES



TUBE RACKS

Part Number	Tube Size	Max # Tubes
AP02-P-4	1/4	2
AP10-P-4	1/4	10
AP07-P-6	3/8	7
AP06-P-8	1/2	6

TUBE CUTTER

Part Number
AP-TC

AQ COLOR COORDINATED SNAP-ON IDENTIFICATION CAPS

Used in Coordination with Colored Plastic Tubing for Simplification in Plumbing

Part Number	Tube O.D.
AQCAP-2*	1/8"
AQCAP-5/32*	5/32"
AQCAP-3*	3/16"
AQCAP-4*	1/4"
AQCAP-6*	3/8"
AQCAP-8*	1/2"
AQCAP-10*	5/8"

EXAMPLE: AQCAP-4R, RED COLOR SNAP ON ID CAP

Part Color	Color Code
Blue	B
Black	BL
Green	GN
Red	R
Orange	O
Violet	V
Yellow	Y
Gray	GR

** Made to Order – consult factory for price and availability.*

EMERGENCY REPAIR KITS



With the Alkon DOT Emergency Repair Kit, fixing a malfunction has never been easier. Once the problem is located, use the tube cutter to make a clean cut, then simply push to connect the tubing into an Alkon fitting to create an airtight seal. No further tools are necessary!

We understand the value of a quick, effective, do-it-yourself repair to ensure that not only will you get right back on the road, but more importantly, your equipment will be running as smoothly as ever.

Considering everything you can plan for, why let something ruin your entire trip when it could be fixed so easily? Equip your vehicle with the Alkon DOT Emergency Repair Kit and you'll have nothing but the open road ahead.

DOT EMERGENCY REPAIR KITS

PART NUMBER	INCLUDES
AQ62-DOT-KIT-1	Reusable push-in unions for 1/4", 3/8" & 1/2" tubing and tube cutter.
AQ62-DOT-KIT-2	Reusable push-in unions for 5/32", 1/4", 3/8" & 5/8" tubing and tube cutter.

MANIFOLDS

WITH PRE-INSTALLED PUSH-IN FITTING CARTRIDGES



We offer custom manifolds for DOT applications.
Please consult our factory if you need more information.

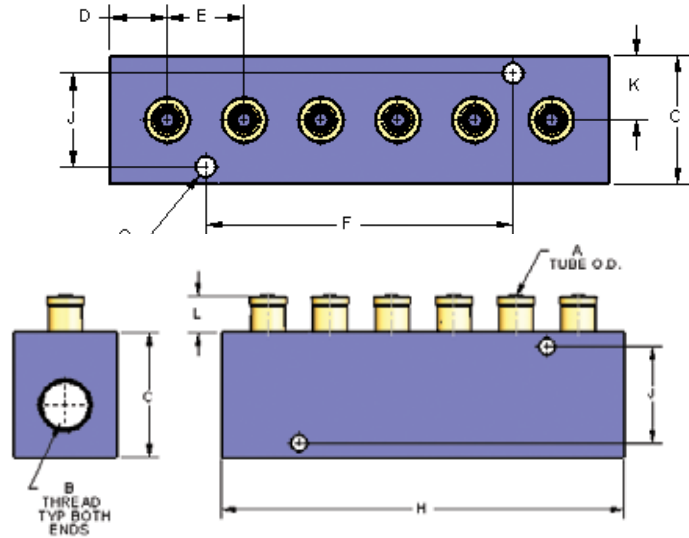

MQ22 MANIFOLDS WITH PUSH-IN FITTINGS

Part Number	Number Outlets	A-Tube O.D.	B-Pipe Thread	C	D	E	F	G	H	J	K	L
MQ22-2X4-4	4	1/8	1/4	1.00 Sq.	0.50	0.75	1.50	0.17	3.25	0.70	0.50	0.47
MQ22-2X4-6	6	1/8	1/4	1.00 Sq.	0.50	0.75	3.00	0.17	4.75	0.70	0.50	0.47
MQ22-2X4-8	8	1/8	1/4	1.00 Sq.	0.50	0.75	4.50	0.17	6.25	0.70	0.50	0.47
MQ22-2X4-10	10	1/8	1/4	1.00 Sq.	0.50	0.75	6.00	0.17	7.75	0.70	0.50	0.47
MQ22-5/32X4-4	4	5/32	1/4	1.00 Sq.	0.50	0.75	1.50	0.17	3.25	0.70	0.50	0.47
MQ22-5/32X4-6	6	5/32	1/4	1.00 Sq.	0.50	0.75	3.00	0.17	4.75	0.70	0.50	0.47
MQ22-5/32X4-8	8	5/32	1/4	1.00 Sq.	0.50	0.75	4.50	0.17	6.25	0.70	0.50	0.47
MQ22-5/32X4-10	10	5/32	1/4	1.00 Sq.	0.50	0.75	6.00	0.17	7.75	0.70	0.50	0.47
MQ22-3X4-4	4	3/16	1/4	1.00 Sq.	0.50	0.75	1.50	0.17	3.25	0.70	0.50	0.57
MQ22-3X4-6	6	3/16	1/4	1.00 Sq.	0.50	0.75	3.00	0.17	4.75	0.70	0.50	0.57
MQ22-3X4-8	8	3/16	1/4	1.00 Sq.	0.50	0.75	4.50	0.17	6.25	0.70	0.50	0.57
MQ22-3X4-10	10	3/16	1/4	1.00 Sq.	0.50	0.75	6.00	0.17	7.75	0.70	0.50	0.57
MQ22-4X6-4	4	1/4	3/8	1.13 Sq.	0.63	0.75	1.50	0.18	3.50	0.85	0.56	0.67
MQ22-4X6-6	6	1/4	3/8	1.13 Sq.	0.63	0.75	3.00	0.18	5.00	0.85	0.56	0.67
MQ22-4X6-8	8	1/4	3/8	1.13 Sq.	0.63	0.75	4.50	0.18	6.50	0.85	0.56	0.67
MQ22-4X6-10	10	1/4	3/8	1.13 Sq.	0.63	0.75	6.00	0.18	8.00	0.85	0.56	0.67
MQ22-6X6-4	4	3/8	3/8	1.13 Sq.	0.63	0.75	1.50	0.18	3.50	0.85	0.56	0.95
MQ22-6X6-6	6	3/8	3/8	1.13 Sq.	0.63	0.75	3.00	0.18	5.00	0.85	0.56	0.95
MQ22-6X6-8	8	3/8	3/8	1.13 Sq.	0.63	0.75	4.50	0.18	6.50	0.85	0.56	0.95
MQ22-6X6-10	10	3/8	3/8	1.13 Sq.	0.63	0.75	6.00	0.18	8.00	0.85	0.56	0.95



What can we do for you?

Our business is connections, and the most important connections we make are with our customers. Whether it's a custom order on short notice, design assistance, or Early Bird notices on specials and new products by email, we always do our best for you.



Keeping the world moving and working.

Get connected.

419.333.7000 or sales@alkoncorp.com



ALKON CORPORATION

728 Graham Drive | Fremont, OH 43420
P: 419.333.7000 | F: 419.355.9211
sales@alkoncorp.com



www.alkoncorp.com